

# *“Scout Regen”*

## *Shortwave Regenerative Receiver*



Dual band receiver covering 3.5 to 10 MHz

*Hendricks QRP Kits*

## ***Table of Contents***

Introduction – Note from Doug Posted to the Web April 21, 2009.....	4
Acknowledgements.....	5
Brief Specifications.....	5
Tools Needed.....	5
Soldering tips.....	6
First section – Mounting the Battery Terminals.....	10
Battery Section Tests.....	14
Audio Amplifier Section.....	15
Audio Amplifier Tests.....	19
Regen Detector Section, Part 1.....	22
Regen Detector Section, Part 1 tests.....	28
Regen Detector Section, Part 2.....	29
Regen Detector Section, Part 2 tests.....	31
Adding Decals to the Case.....	32
Regen Detector Section, Part 3.....	34
Regen Detector Section Part 3 tests.....	43
Microphonic Effects.....	44
Notes on Tuning a Regenerative Receiver.....	44
Other Operating Notes.....	45
Parts List by Schematic Reference Numbers.....	45
Schematic.....	46

## ***List of Figures***

Figure 1. Kit hardware.....	8
Figure 2. Other electronic parts.....	8
Figure 3. Kit Capacitors.....	9
Figure 4. Chassis and decal sheet.....	9
Figure 5. Wire used in the kit.....	9
Figure 6. Top side view of the bare PC board.....	10
Figure 7. Find the 9v battery “+” symbol as shown above.....	10
Figure 8. Make sure the battery + terminal is lined up right on the board.....	11
Figure 9. Make sure the battery clip is installed flush to the top of the PC board.....	11
Figure 10. Bottom view of the 9v battery connector pins.....	12
Figure 11. Bend the leads on two of the 1N4004 diodes as shown.....	12
Figure 12. Diodes D4 and D1 mounted with band oriented marked.....	13
Figure 13. When inserting the diodes, bend the leads outward to keep them in place for soldering.....	13
Figure 14. Picture of soldered leads.....	13
Figure 15. View of trimmed leads after soldering.....	14
Figure 16. Measuring the voltage across the installed 9v battery.....	14
Figure 17. Test points for voltage measurement.....	15
Figure 18. Completed Audio Amplifier Section.....	16
Figure 19. Mounted parts leads bent out to hold them into place prior to soldering.....	16
Figure 20. D5, D6 band orientation shown.....	16

Figure 21. Lead forming for R7 and R10 .....	17
Figure 22. Resistor bodies R7, R10 flush with the PC board .....	17
Figure 23. Orientation of IC1 dot marking and C13 polarity marking.....	17
Figure 24. Polarity markings for C6 and C14.....	18
Figure 25. Bottom side view of Audio amplifier section.....	18
Figure 26. Measuring the voltage across the installed 9v battery.....	19
Figure 27. Location of temporary lead scrap .....	19
Figure 28. Measuring the current drain of the audio amplifier section .....	20
Figure 29. Where to touch for the “hum test”.....	21
Figure 30. Most of the electronic parts on the right side of the board will be installed in this section ....	22
Figure 31. C3 and C5 placed on the board. <i>Do not solder!</i> C3 trimmer setting.....	22
Figure 32. Temporarily mount PC Board to the chassis and C3, C5 to the front panel .....	23
Figure 33. Solder points shown for C3 and C5.....	24
Figure 34. C3 and C5 after soldering and trimming of bottom side leads.....	24
Figure 35. Leading forming shown for the zener diode, D2.....	25
Figure 36. Polarity of D2 and C9.....	25
Figure 37. Comparison between a 1K resistor and a 1 mH molded choke.....	26
Figure 38. D3 orientation shown. 1 mH choke and 1 K resistor shown installed .....	26
Figure 39. C3C before and after. Leads need to be straightened out.....	27
Figure 40. Forming leads for C8. Leads spacing is too narrow.....	27
Figure 41. Measuring the voltage across the installed 9v battery.....	28
Figure 42. Measuring the current drain of the audio amplifier section .....	28
Figure 43. In this section we will install most of the larger hardware pieces on the right side.....	29
Figure 44. Close up of the two switches S1 and S3.....	30
Figure 45. Q1 and Q2 mount with flat side matching the silk screen for the part.....	31
Figure 46. Measuring the voltage across the installed 9v battery.....	31
Figure 47. Measuring the current drain of the kit to date section.....	32
Figure 48. Location of the decals for the front panel.....	34
Figure 49. Drilling template for L1, the regen main coil. Template is 1.5”x1.5” .....	34
Figure 50. L1 drilling preparation.....	34
Figure 51. Starting the bottom winding of L1 .....	35
Figure 52. Tying off far end of first winding of L1 .....	36
Figure 53. Start of L1 middle winding.....	36
Figure 54. Tying off L1 middle winding .....	37
Figure 55. Top winding of L1.....	38
Figure 56. All six leads of L1 trimmed and solder tinned. ....	38
Figure 57. L1 Mounted in the PB board .....	39
Figure 58. Cut five wires 2.5” in length and install on R6 pads.....	40
Figure 59. R6 (back view/front view) mounted to the front panel. ....	41
Figure 60. Mount the PC board with the four corner screws. Keep screws loose!.....	41
Figure 61. Mount C3 C5 to front panel. Keep screws loose! .....	41
Figure 62. Mounting hardware for the shafts for C3 and C5.....	42
Figure 63. Knob order on the front panel. ....	42
Figure 64. Measuring the voltage across the installed 9v battery.....	43
Figure 65. Measuring the current drain of the kit to date section.....	43

## Introduction – Note from Doug Posted to the Web April 21, 2009

I have always had this love affair with Regen Radios. There is just something about them that fascinates me. I don't know why? Maybe it is because the operator has to "operate" or work at tuning in a signal. It takes a little bit of getting used to, but when you get it down, it is so much fun. You tune across the band. You hear a signal, adjust the regen control, retune, adjust the regen, retune with the fine tune, turn down the volume, Ahh there it is, two guys talking on 75 meters in the midwest and you are listening to them on a radio that you built!! It doesn't get any better than that. Maybe it does. It is even a bigger thrill when you hear a foreign broadcast station, or Arnie Coro and his DXers Unlimited SWL show from Radio Habana!!

So, I decided to kit one. I contacted Charles Kitchin (N1TEV) several years ago and asked him if I could have permission to use his design in a regen kit. We would lay out our own board and make some minor changes, but it would be based on his circuit. Charles was very gracious and said go for it. What did I want the kit to be? I wanted it to have all through hole parts, battery and antenna connectors on board, and have its own case or chassis that was pre-punched, and I wanted it easy to build. Last fall at Pacificon, Dan Tayloe, Ken and I sat down and talked about the regen. I told them I wanted to add a regen kit to the lineup, and they agreed that it would be a good addition. I then asked Dan if he would do the board layout and Ken would handle the chassis design. They got together and went to work. In January, they had a prototype ready to go. It used a toroid for the main coil, and while it worked, it didn't work like we thought it should, and it was complicated. Since we wanted this to be a simple kit for beginners, and especially aimed at boy scouts for the radio merit badge, we had to make some changes.

Dan came up with the idea of using CVPC pipe as a coil form. It made the winding of the coil much easier to do, and was just what we needed. We made another round of prototype boards and also ordered a prototype case. While we were at it, I asked Dan if we could add a 2.1 mm power connector along with the onboard battery clips since we had lots of room on the board. Sure, no problem and a good idea. (More on this later).

We ordered another round of prototype boards and I sent them to Dan, Chuck Adams and Jay Bromley to build and give us feedback. The board worked great. Chuck and Jay both were impressed with the receiver and Chuck even took a ton of pictures and put them on his website. These guys were building from just a schematic and a description of the coil winding, NOT a manual. But they are experienced builders and it was a snap to build. Both Chuck and Jay reported that they were spending way too much time playing with the regen. Remember that 2.1mm power jack that I wanted to add just because we had some room? Well, somehow, the leads got switched, and the center lead was negative and the shell was positive. *<Sorry Doug! – Dan>* Chuck found it and emailed me. Oh no!! I had just placed an order for 500 boards.

I got on the phone and found out that the boards were 75% done. Now I had a tough decision. Do I go with the boards and have everyone cut traces and add jumpers? Not a good idea on a kit that we want to have beginners build. They need a perfect board!! But that was going to cost hundreds of dollars. Sometimes you have to bite the bullet. It is part of the cost of doing business. I called the board house, canceled the order, and told them that I would be sending the corrected files the next day. Dan fixed the

problem, and we ordered new boards. We check every set of boards that we do on our kits. But sometimes things slip through. This is what happened this time. When Chuck, Dan and Jay first built the board, they all used a 9V battery for power. Thank goodness Chuck decided to use another battery and a 2.1mm connector. His 9V battery had run down, so, he hooked up a gel cell and when it didn't work, he did some testing and found the problem. It was expensive to have to cancel the board order, but at least the problem was found before we shipped a bunch of kits!

Dan is working on the manual now, and as soon as it is finished, we will post it to the web page. But if you would like to see a preview of what the regen kit will look like, go to [www.qrpkits.com](http://www.qrpkits.com) and click on the thumbnail picture of the regen. It will take you to a page with pictures and a description.

## Acknowledgements

Charlie Kitchin for the basic receiver design

Ken Locasale for the Chassis layout, decals, and much mechanical engineering assistance (part footprint checks, front panel layout, etc)

Dan Tayloe for the board layout, minor circuit modifications, and most of the manual

Chuck Adams, Jay Bromley, Ken Locasale, and Dan Tayloe for prototype builds

## Brief Specifications

### Dual band receiver

- Lower Band: Roughly 3.3 to 5.1 MHz
- Higher Band: Roughly 5.1 MHz to 10+ MHz

**Receiver sensitivity:** -130 dBm or 0.1 uV (cw regen mode). Sensitivity reduced a few dB at 3.5 MHz

**Audio output:** Headphone level only with diode audio limiters for listener safety

**Power supply:** 2.1 mm jack for external 12v input or 9v on board battery

**Current drain:** Approximately 8 ma

## Tools Needed

Soldering iron – low power 30w iron. Available from Radio Shack such as 64-2070.

Solder. 60/40 rosin core. Available from Radio shack such as 64-009

Side cutters.

Fresh 9v battery.

Multi-meter (For tests to measure current, voltage and ohm meter coil winding checks)

Small screw drivers (straight blade for knob set screws, Philips blade for polyvaricon mounting screws)

Medium screw driver (straight blade for PC board mounting screws)

Small ruler (measuring wire lengths)

Scotch tape (used to secure drilling template to PVC tube)  
Hot glue gun (Used on L1 main coil to reduce potential microphonics)  
Wire stripper (optional)  
Knife (if wire stripper is not used)

It would be useful to print out a blank and white (grayscale) version of this manual in order to keep track of where the builder is in the process. Then, reference can be made back to the color version on a computer monitor if needed.

## **Soldering tips**

If you are a beginner, new to soldering, there are a number of resources on the web to help you get on the right track soldering like a pro.

[www.aaroncake.net/electronics/solder.htm](http://www.aaroncake.net/electronics/solder.htm)

Note: Don't worry about the steel wool on this project

<http://www.kpsec.freeuk.com/solder.htm>

Note: As long as the wire is relative small (15 to 30w), the heat sink really is not needed.

[http://www.elecraft.com/TechNotes/NOSS\\_SolderNotes/NOSS\\_SolderNotesV6.pdf](http://www.elecraft.com/TechNotes/NOSS_SolderNotes/NOSS_SolderNotesV6.pdf)

Here is a YouTube video:

[http://www.youtube.com/watch?v=I\\_NU2ruzyc4](http://www.youtube.com/watch?v=I_NU2ruzyc4)

### Parts List Summary

This is an inventory of the parts that should be included in this kit, both in list and picture form. The schematic and parts list by schematic reference number is at the back of the manual.

Part	Value	Device
1	Bat terminal	PC mount battery clip "+"
1	Bat terminal	PC mount battery clip "-"
7	0.01 uf	Capacitor
2	10 uf	Electrolytic Capacitor
1	100 pf	Capacitor
1	1000 pf	Capacitor
2	220 uf	Electrolytic Capacitor
1	39 pf	Capacitor
1	5 pf	Capacitor
2	POLYVARICON	Polyvaricon variable capacitors
5	1N4004	Power diode
1	1N4736A	Zener Diode
1	LM386-N4	LM386
J1	COMPRESSION_JACK	Antenna connector jack
J2	HEADPHONE_PCB	Headphone jack
J3	DC_PWR	DC power Jack

Part	Value	Device
1	1.5" length 0.5" PVC 5/8" OD	1.5" PVC coil form
1	1 mH	Molded Choke (mH, not uH)
1	2N3904	transistor
1	2N5485	transistor
1	10	10 ohm Resistor
1	33	33 ohm Resistor
1	51	51 ohm Resistor
1	1K	1K ohm Resistor
2	1M	1M ohm Resistor
4	2.7K	2.7K ohm resistor
1	100K	Fine Tune variable resistor
1	10k	Volume w/ power switch
S1	MINI_SPST	MINI_SPST_SLIDE
S3	MINI_SPST	MINI_SPST_SLIDE

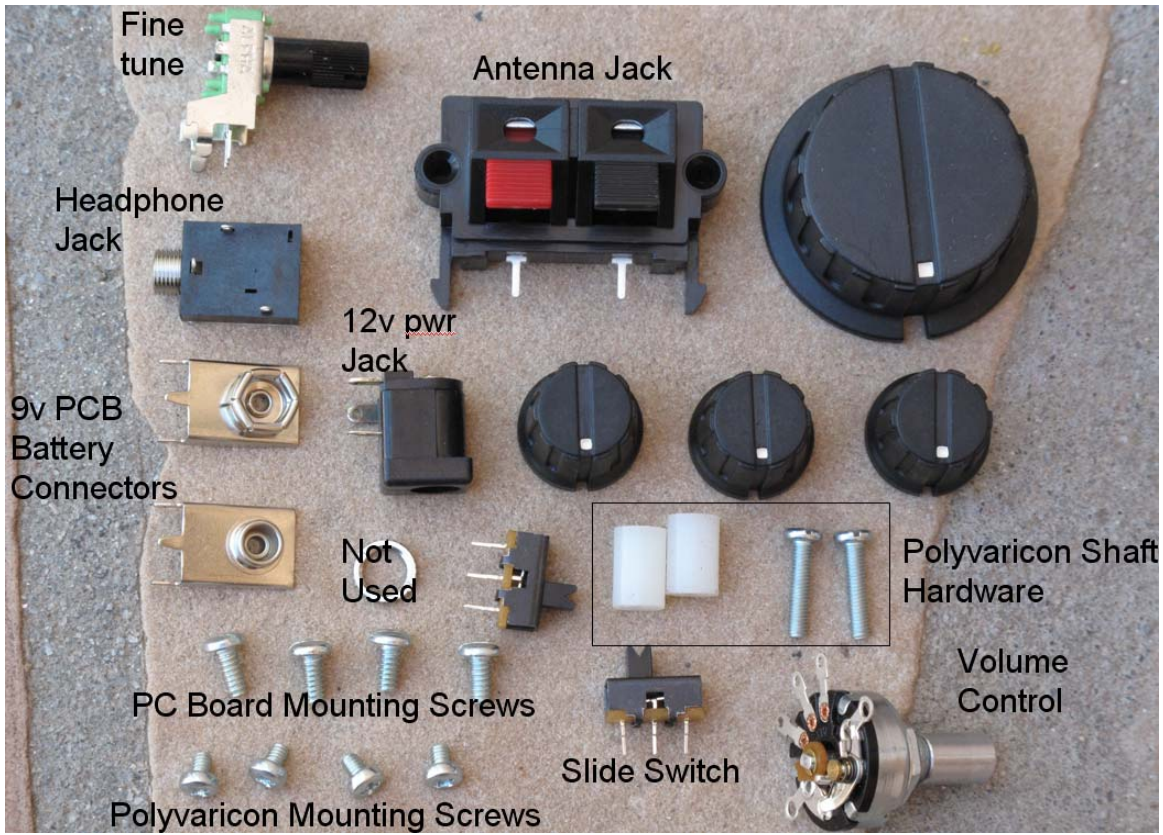

Figure 1. Kit hardware

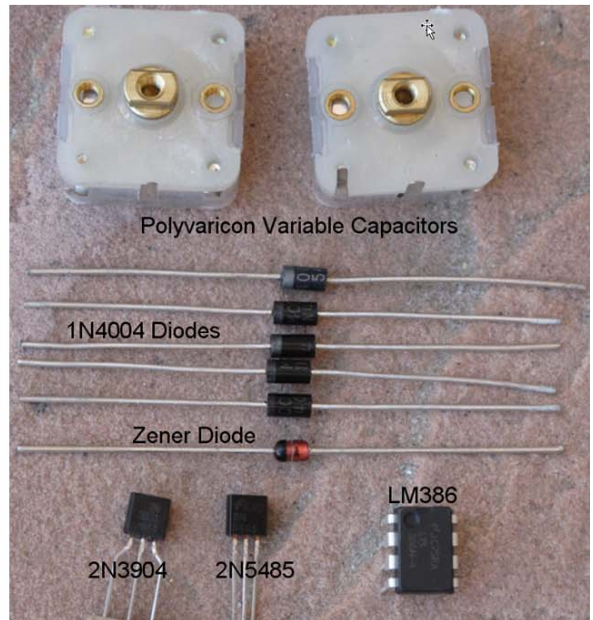

Figure 2. Other electronic parts



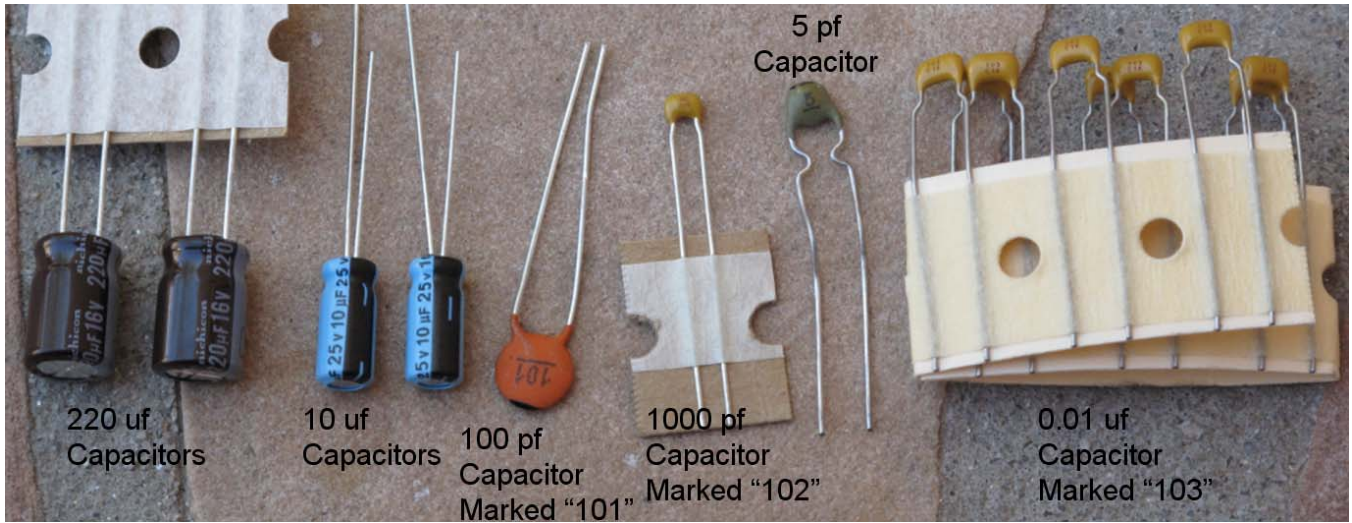

Figure 3. Kit Capacitors



Figure 4. Chassis and decal sheet



Figure 5. Wire used in the kit

## Bare PC Board

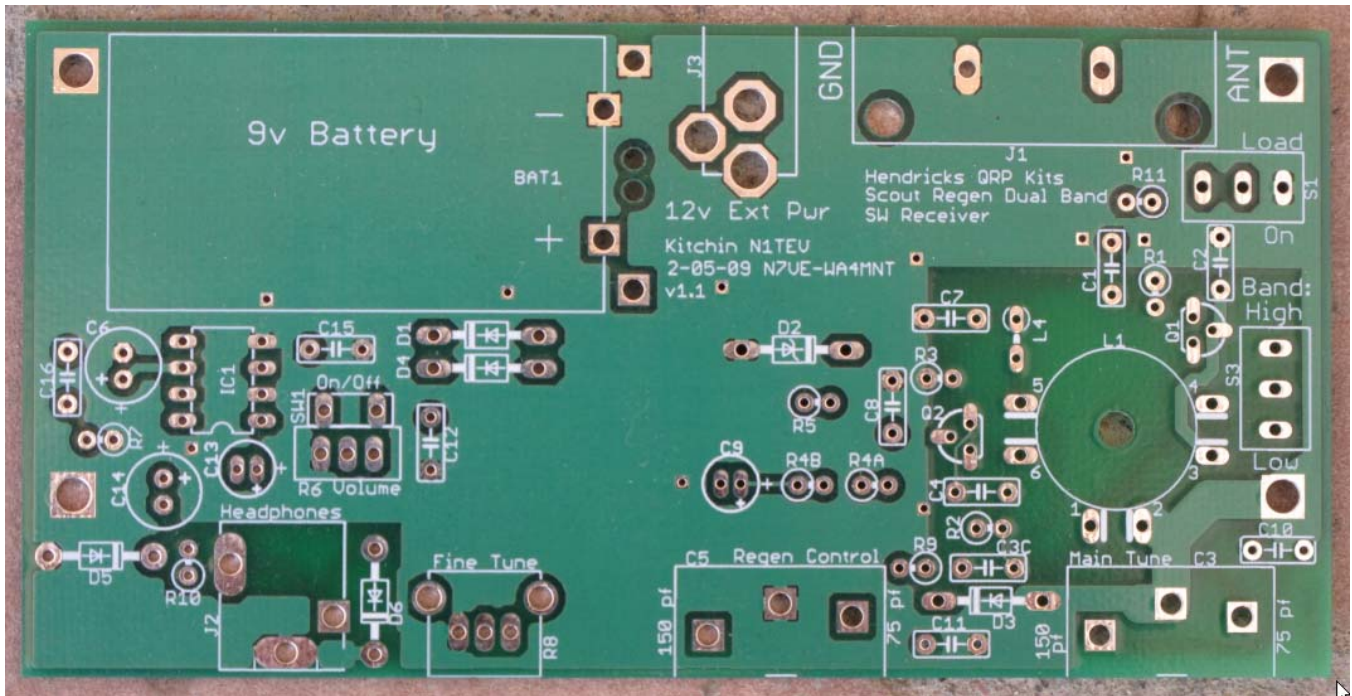

Figure 6. Top side view of the bare PC board

## First section – Mounting the Battery Terminals

Mounting the battery terminals is probably the hardest step in this entire kit because the battery terminals do not accept solder well. You will need to supply your own 9v battery in order to properly install the 9v battery clips



Figure 7. Find the 9v battery “+” symbol as shown above

□ Clip the 9v battery clips on to the battery so that they line up as shown above.

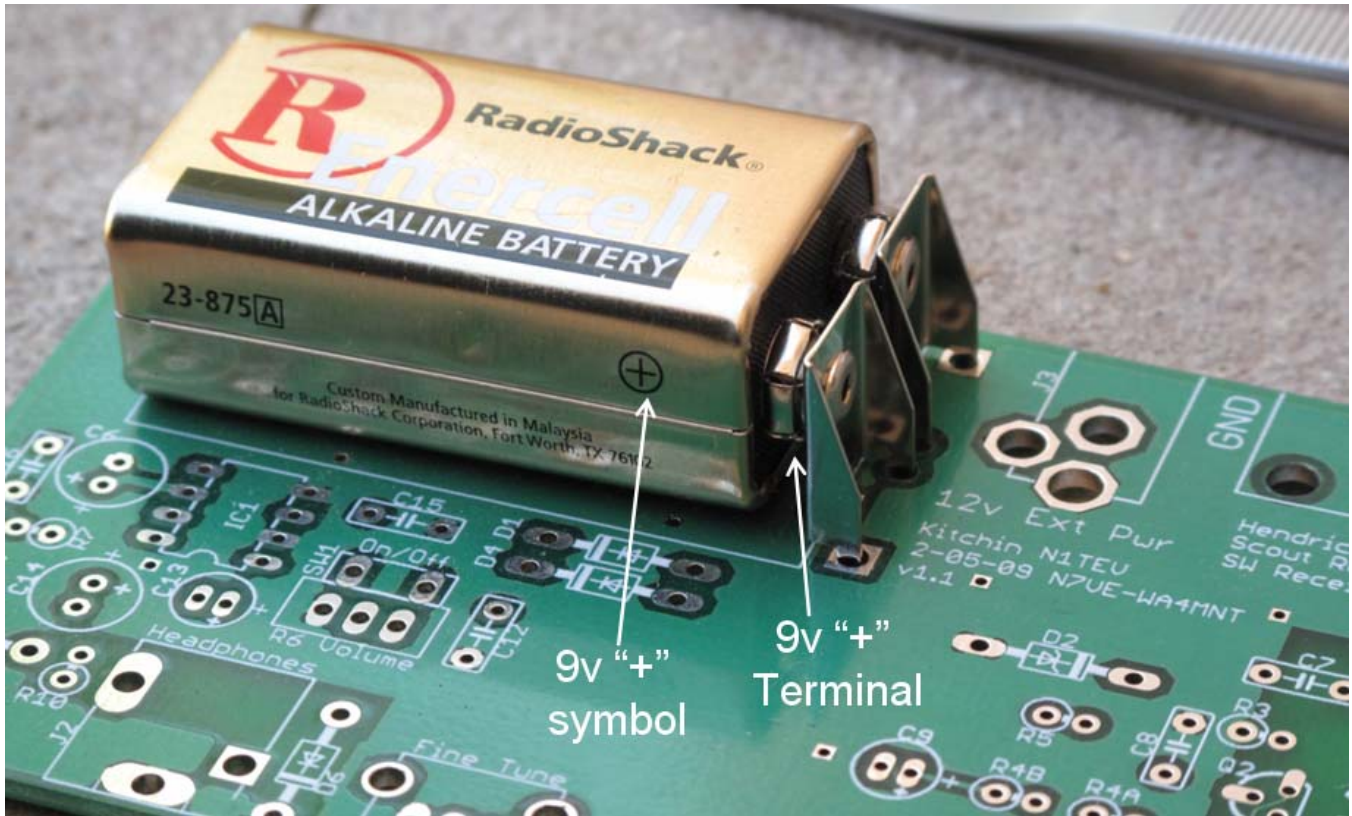

Figure 8. Make sure the battery + terminal is lined up right on the board

Next, test fit the battery and the terminals on the PC board. ***Make very, very sure the “+” terminal of the 9v battery is mounted as shown.*** We do not want to mount the battery in backwards!

The next step is to solder the battery terminal to the PC board. ***Solder the terminal to the board with the battery attached.*** This will make sure that the battery clips are lined up and spaced properly. ***Make sure the battery clips are soldered flush to the top of the board.*** Push on the battery as the clips are being soldered into place.



Figure 9. Make sure the battery clip is installed flush to the top of the PC board.

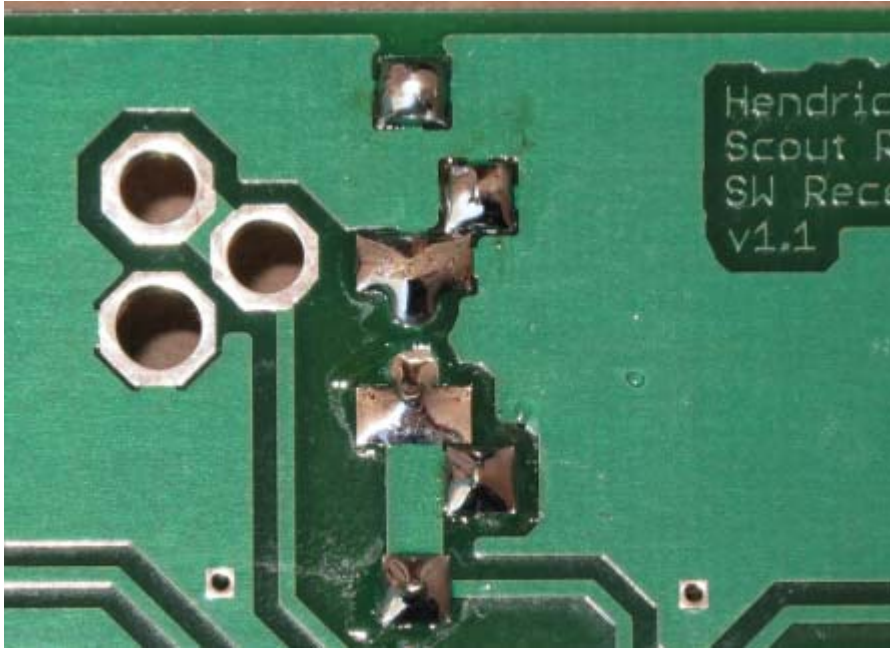

Figure 10. Bottom view of the 9v battery connector pins

When soldering in the 9v terminal pins, the PC board pads readily accept solder, but the pins seem to cause the solder to bead away from them. At first the pins will look like an island in the middle of a sea of solder. *Keep the soldering iron on the pins for an extra period of time until the solder quits beading away from the pins and instead flows onto the pins.*

*After the battery clips are installed, remove the 9v battery.*

Next take two 1N4004 diodes and bend the leads as shown below:



Figure 11. Bend the leads on two of the 1N4004 diodes as shown

Take two of the 1N4004 diodes and pre-form the leads as shown above so that they will fit in their holes on the PC board.

When mounting the diodes on the board, rock them slightly to make sure the diodes mount completely flush with the top surface of the PC board as shown below.

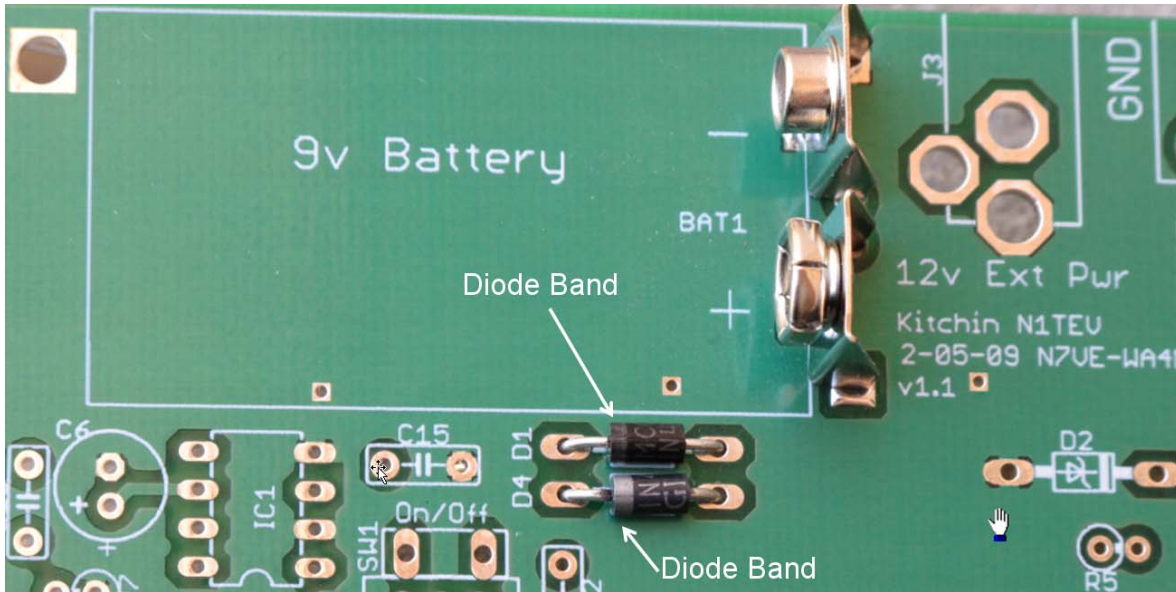

Figure 12. Diodes D4 and D1 mounted with band oriented marked

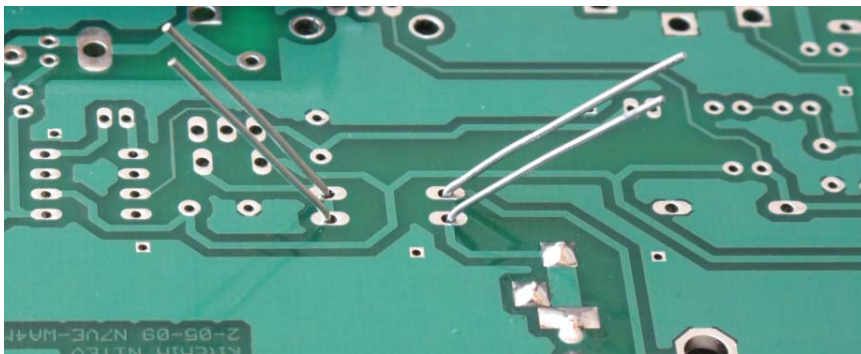

Figure 13. When inserting the diodes, bend the leads outward to keep them in place for soldering

Install □ D4, □ D5 1N4004 diodes. ***Important! Install the diodes with the banded end pointed as shown above.*** The bands on the diodes should match the board outline.

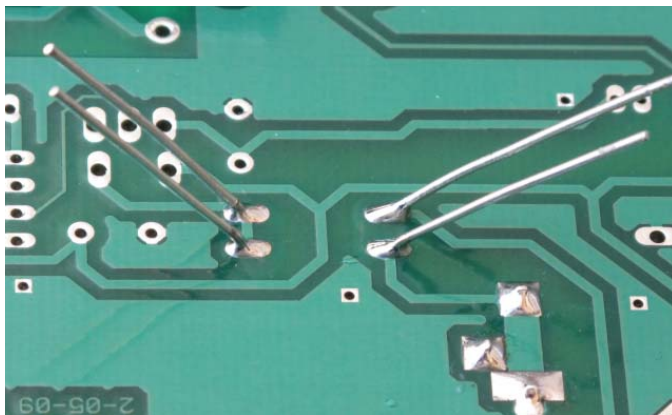

Figure 14. Picture of soldered leads

When the leads are soldered, the solder should wick smoothly from the PC board pad to the leads. This happens as the heat from the soldering iron is applied to both the pad and the lead at the same time and solder is then added to the hot parts. It should only take 1-2 seconds with a soldering iron tip to heat up these parts.



Figure 15. View of trimmed leads after soldering

After the leads have been soldered, *trim the leads close to the board*. We do not want excess wire hanging from the bottom of the board. Excess lead length can short against other parts or the chassis when mounted, so trim the leads very close to the board!

## Battery Section Tests

- Connect the 9v battery to the battery clips

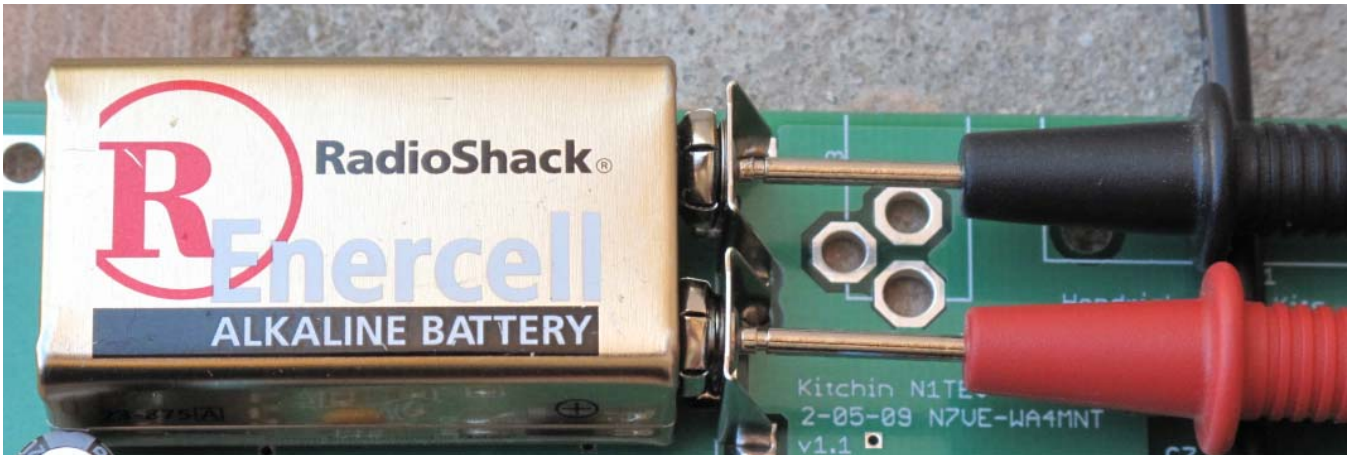

Figure 16. Measuring the voltage across the installed 9v battery.

- Measure the voltage across the battery clips using a voltmeter set to the “DC volts” setting. The voltage should read somewhere in the 8 to 9v range depending on the freshness of the battery

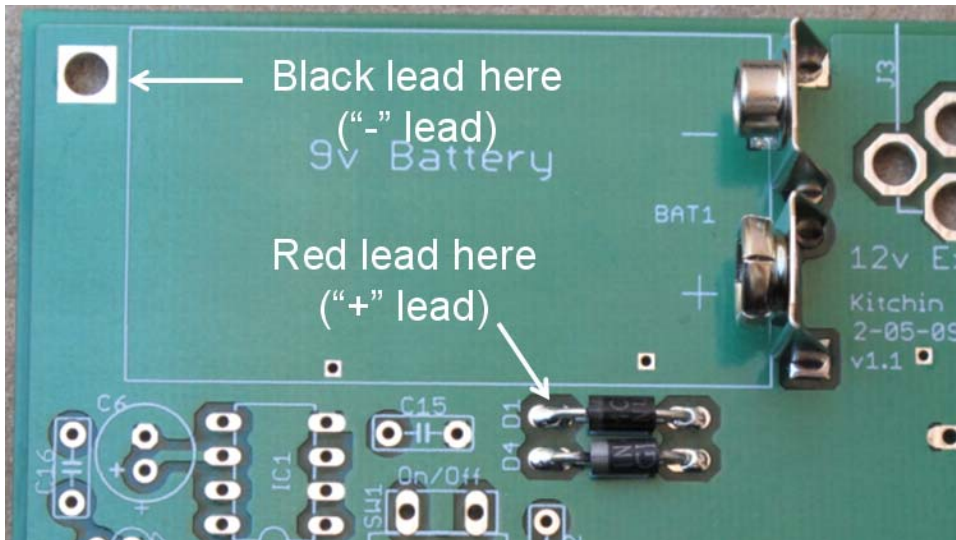

Figure 17. Test points for voltage measurement

□ Measure the voltage across the two points shown above using a voltmeter set to the DC volts setting. Install the 9v battery. Then the voltage should read somewhere in the 7.3 to 8.3v range depending on the freshness of the battery. This voltage is the voltage on the other side of the diodes that have been installed.

*After these tests are finished, remove the 9v battery.*

## Audio Amplifier Section

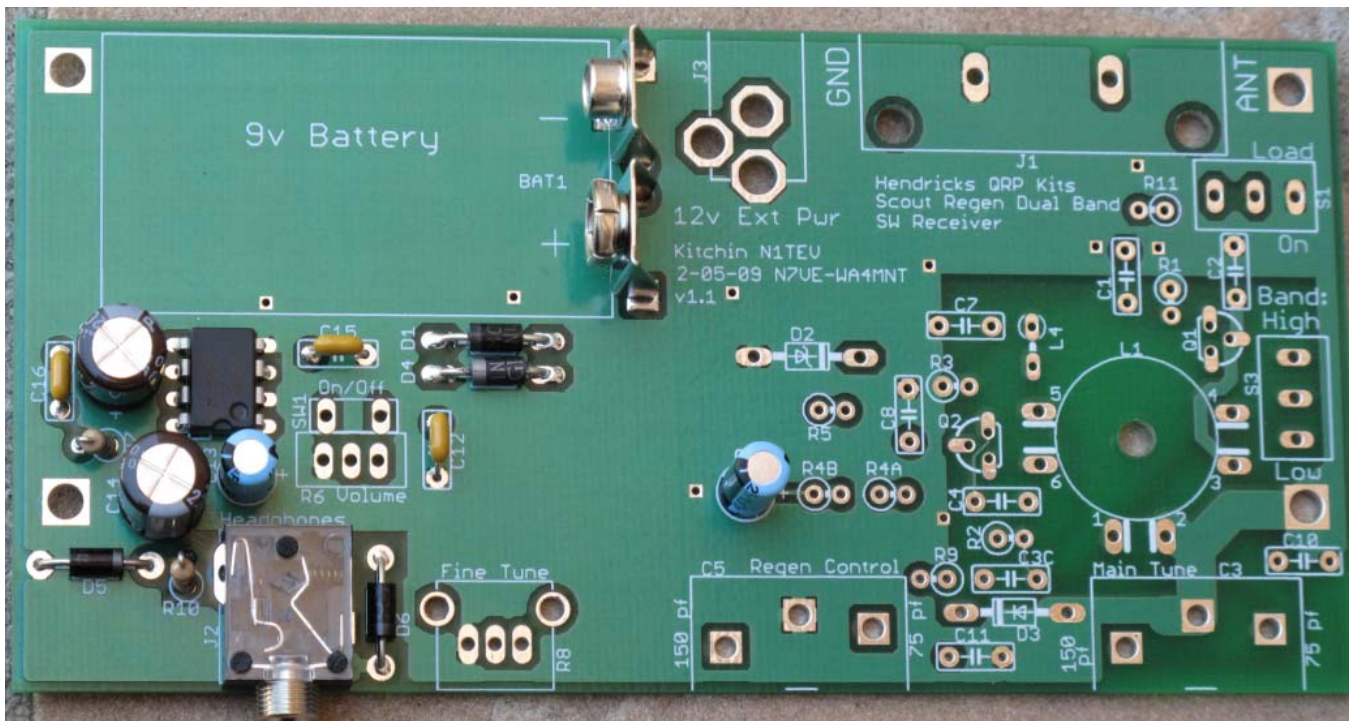

Figure 18. Completed Audio Amplifier Section

□ Install J2, the audio headphone jack as shown above. *When soldering in this part, first solder one pin, then check to make sure that the jack is lined up square on its board outline, then solder the last two pins.*

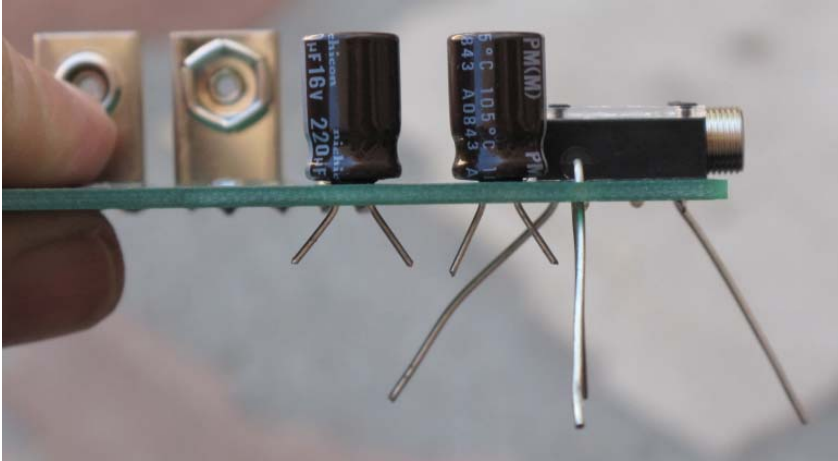

Figure 19. Mounted parts leads bent out to hold them into place prior to soldering.

**Note:** All parts in this kit should be mounted as close to the surface of the PC board as possible. However, when the board is flipped upside down for soldering, a part can slip creating a long lead. To keep this from happening, when inserting a part, the leads are bent out to hold the part into place until it can be soldered.

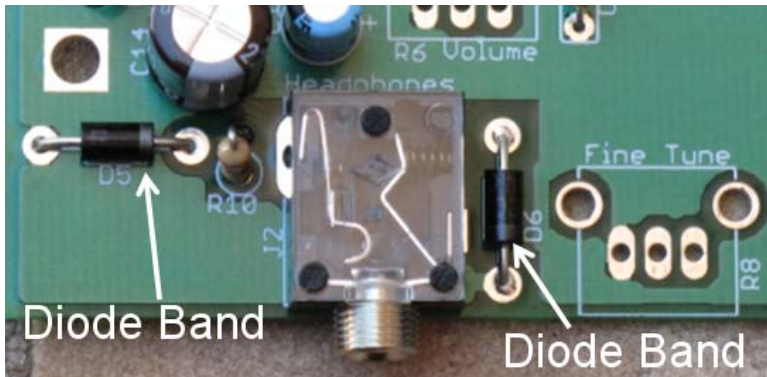

Figure 20. D5, D6 band orientation shown

Install □ D5 and □ D6, 1N4004 diodes. *Make sure the diode bands are oriented as shown above.* The bands on the diodes should match the board outline. These diode leads should be formed in the same way as was done for D1 and D4, and should be mounted flush with the surface of the board.

Install □ C12, □ C15, and □ C16 0.01 uf capacitors (marked “103”). These are the small yellow capacitors on the board in Figure 18 above.



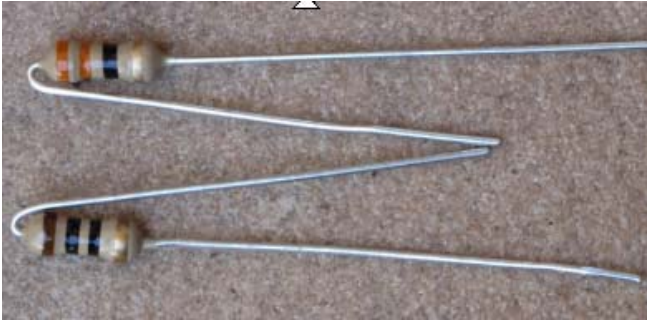

Figure 21. Lead forming for R7 and R10

Next bend the leads for R7 (10 ohms, brown-black-black-gold) and R10 (33 ohms, orange-orange-black-gold) as shown above. This is easily done by hand. Be sure to keep the bend tight to the top of the resistor.

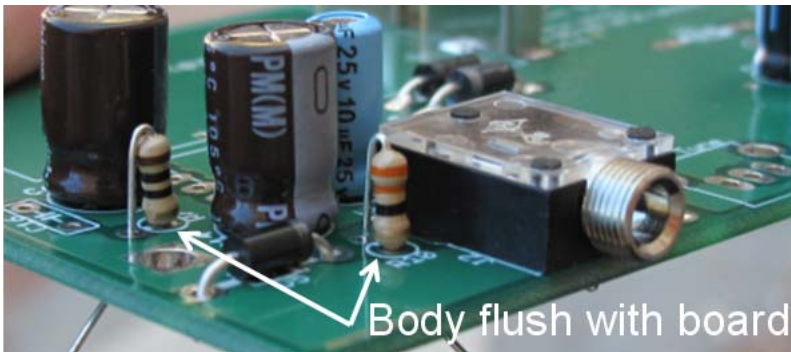

Figure 22. Resistor bodies R7, R10 flush with the PC board

Install □ R7 (10 ohms, brown-black-black-gold) and □ R10 (33 ohms, orange-orange-black-gold). The bottom of the resistor body should be mounted flush with the top of the board.

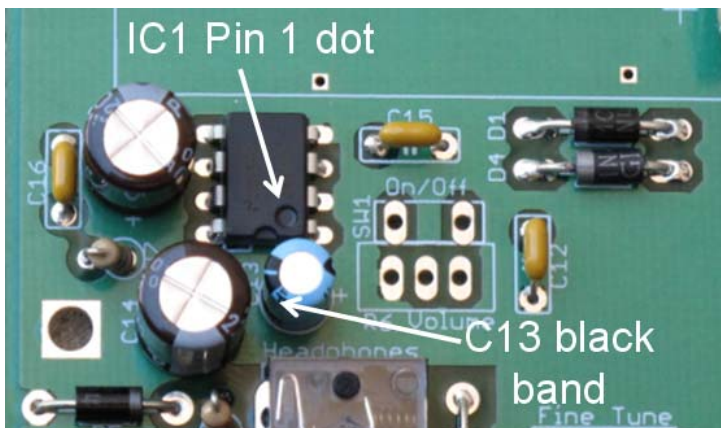

Figure 23. Orientation of IC1 dot marking and C13 polarity marking

□ Install IC1, a LM386 8 pin IC. ***Make sure the pin1 “dot” is oriented as shown above.*** Unlike the other leaded parts, you cannot really bend the pins on the IC off to the side, so when

soldering, push on IC1 and solder two opposite corner pins in place first. With this two opposite corner pins soldered, the rest of the IC pins can be soldered since IC1 will be firmly held by the two soldered pins.

- Install C13, a 10 uf capacitor. ***Make sure the”-“ polarity band is oriented as shown above.***

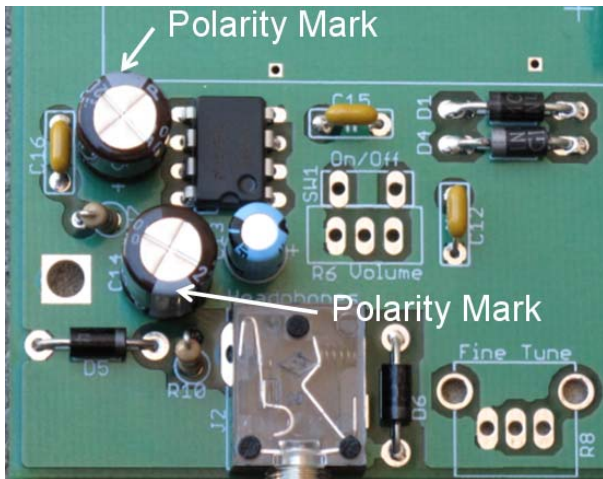

Figure 24. Polarity markings for C6 and C14

- Install C6 and C14, 220 uf capacitors. ***Make sure the “-“ polarity bands are oriented as shown above.***

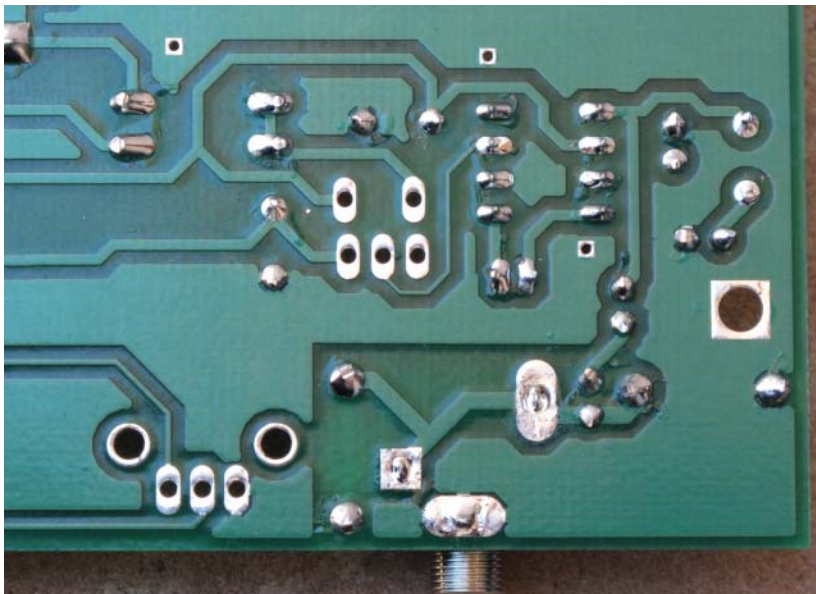

Figure 25. Bottom side view of Audio amplifier section

At this point, check the bottom side and make sure the leads are trimmed short, that there are no visible solder bridges from pad to pad, and that the solder joints look smooth and shiny.

## Audio Amplifier Tests

- Connect the 9v battery to the battery clips

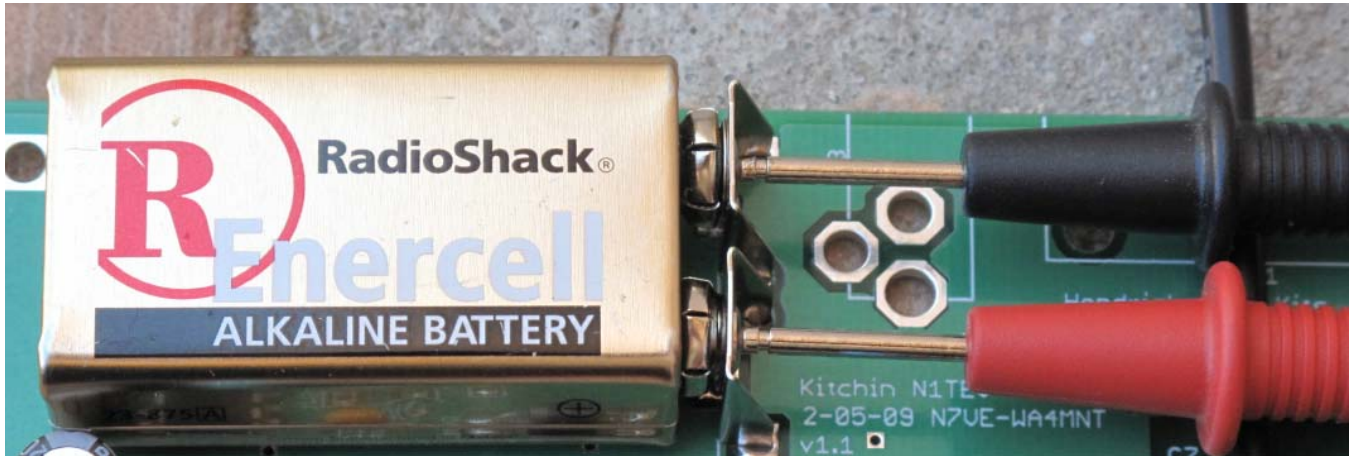

Figure 26. Measuring the voltage across the installed 9v battery.

- Measure the voltage across the battery clips using a voltmeter set to the “DC volts” setting. The voltage should read somewhere in the 8 to 9v range depending on the freshness of the battery

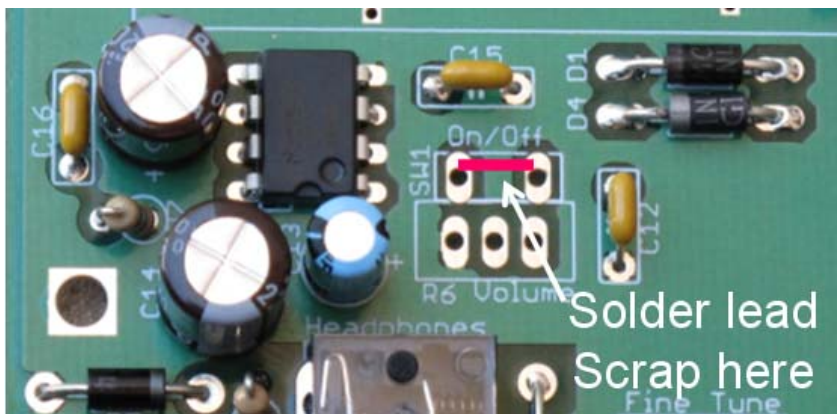
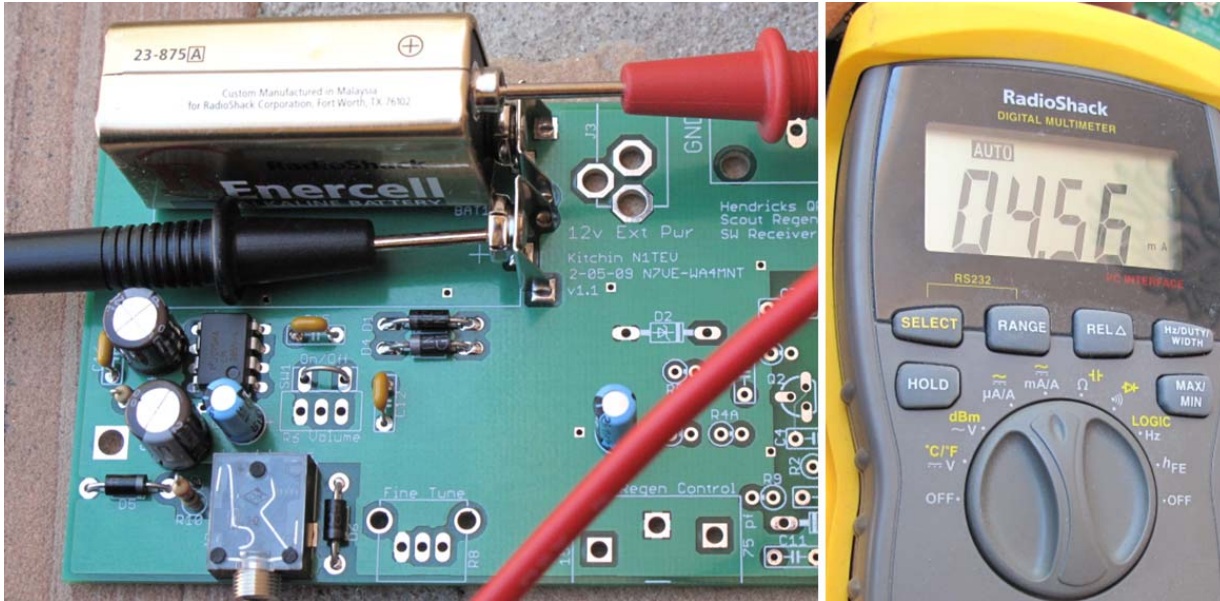

Figure 27. Location of temporary lead scrap

- Take a cut off lead scrap and temporarily solder it across the two pads shown above. This lead is placed on top of the board across the tip of the pads. This is used to simulate the power switch turned on. If possible, try to avoid filling the holes with solder. If they do get filled it is not really a problem.

This solder lead scrap will stay in place until the real switch is put into place, which is the last step of the kit.

□ Measure the voltage across the battery clips using a voltmeter set to the “DC volts” setting. The voltage should read somewhere in the 8 to 9v range depending on the freshness of the battery. This test makes sure that the circuitry that has just been added, which is on the other side of the power switch, has not shorted out the battery.



**Figure 28. Measuring the current drain of the audio amplifier section**

□ Measure the current drain of the kit to this point. As shown in the figure above, disconnect the battery from the + terminal while keeping it connected to the “-” terminal. Set up the volt meter for measuring DC current, then attach the volt meter test leads as shown above. This allows the voltmeter to read the current flowing out of the battery into the circuit.

In this prototype, the current was 4.5 ma. This measured current drain is almost entirely due to the LM386 audio amplifier chip, IC1. This IC has a current drain specification that varies from 4 to 8 ma. The current drain measure for this IC was on the low end of this scale. However, if the current had be 10 ma or higher, this test would indicate a potential problem in the installation of one of the parts, such as IC1 or one of the three large polarized capacitors being installed backwards, or perhaps a solder short on the bottom side of the board.

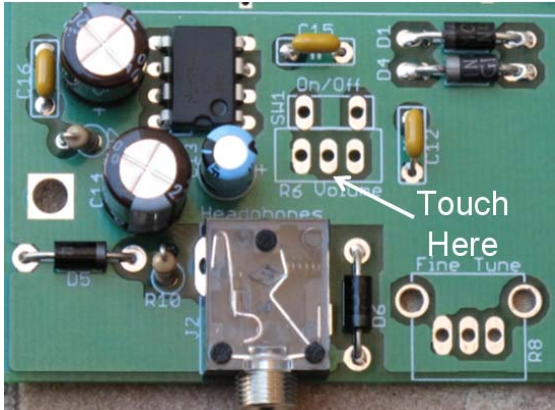

**Figure 29. Where to touch for the “hum test”**

□ Disconnect the voltmeter and reconnect the 9v battery as normal. Next plug in a set of headphones to the front panel audio jack. Next take a scrap lead and use it to touch the center pad of the volume control (R6) as shown in the figure above.

You should be able to hear something when this point is touched. At least, there ought to be a “click” when contact is made. In addition, there should be a “hum” heard in the background. In addition, some might hear audio from one or more radio stations depending on how close you are to a broadcast tower. Any or all of these are good signs that the audio amplifier is working.

***After these tests are finished, remove the 9v battery.***

***Make sure to switch the volt meter out of the “current” mode into the “voltage” mode!***

# Regen Detector Section, Part 1

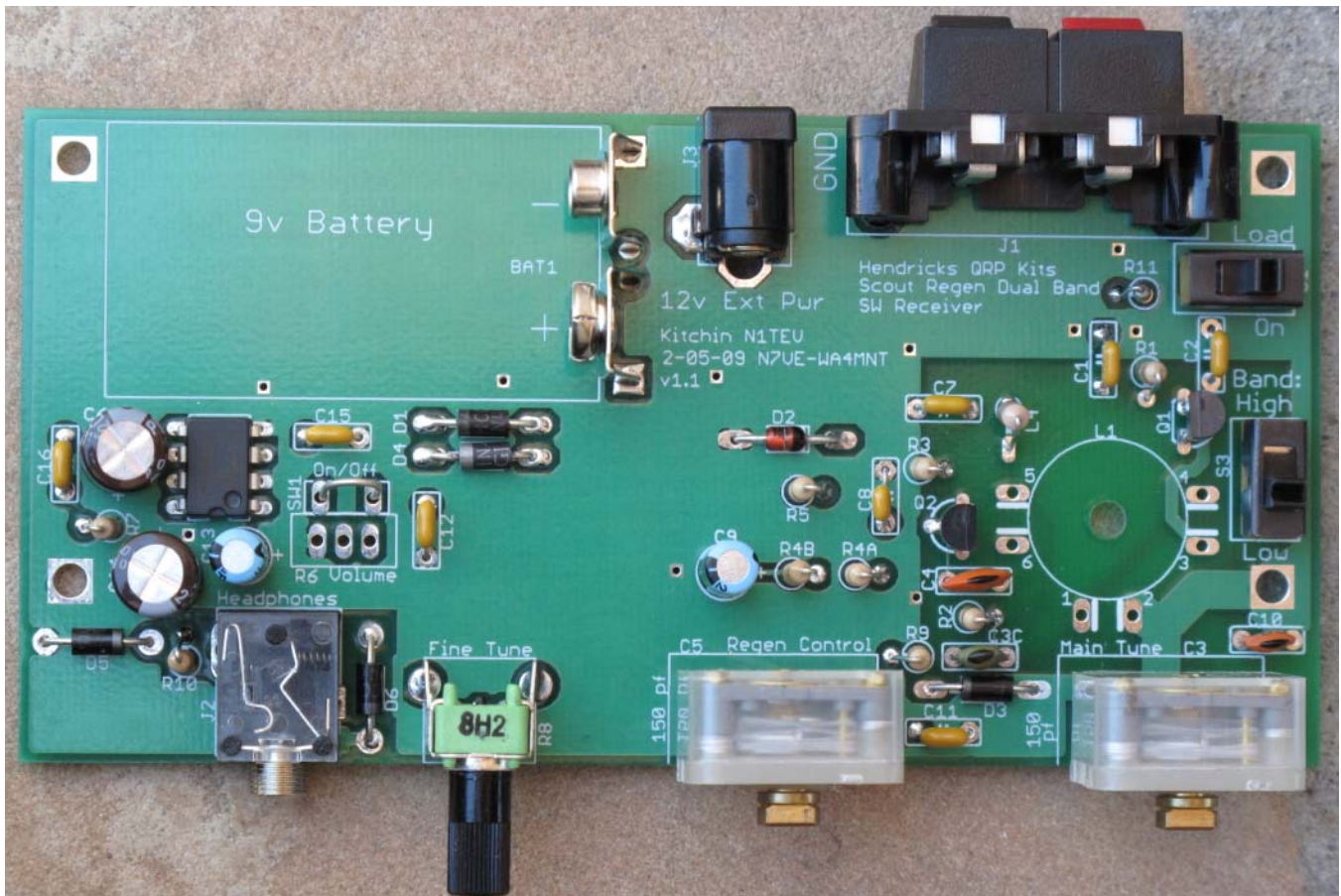

Figure 30. Most of the electronic parts on the right side of the board will be installed in this section

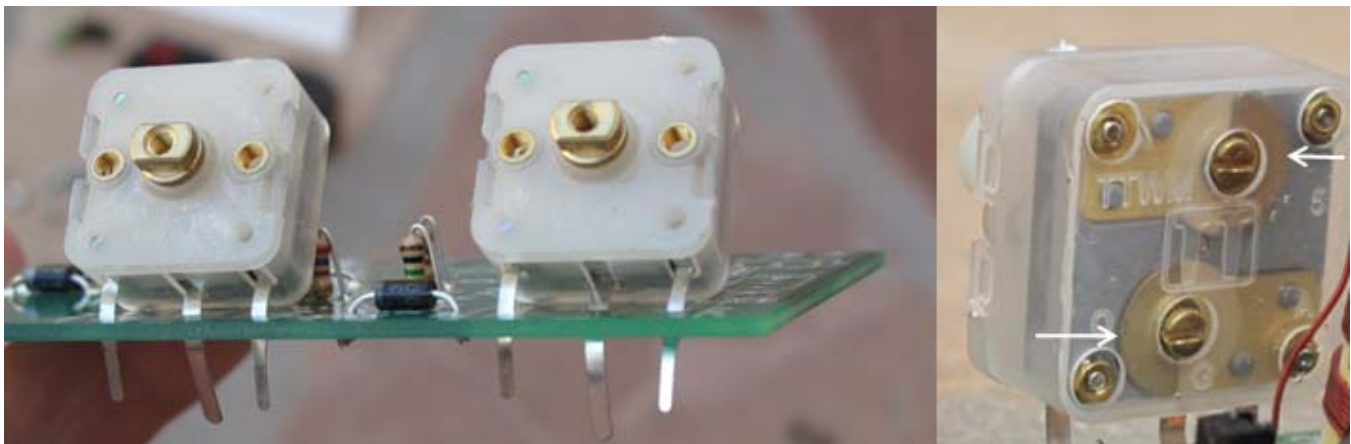

Figure 31. C3 and C5 placed on the board. **Do not solder!** C3 trimmer setting.

**Do not solder!** The very first thing that needs to be done is to install C3 and C5, the polyvaricon caps. These caps need to sit off the board in order for them to be properly mounted to the front panel. **Do not solder!** Set the variable capacitors slightly off the board as shown above and bend the excess leads backwards. **Do not solder!**

At this time the small trimmers on the back of C3 should be rotated until fully unmeshed as shown in the second picture in the figure above. These trimmers set the upper frequency tuning range of the receiver and this raises the frequency as high as possible. The trimmers on C5 should be left alone.

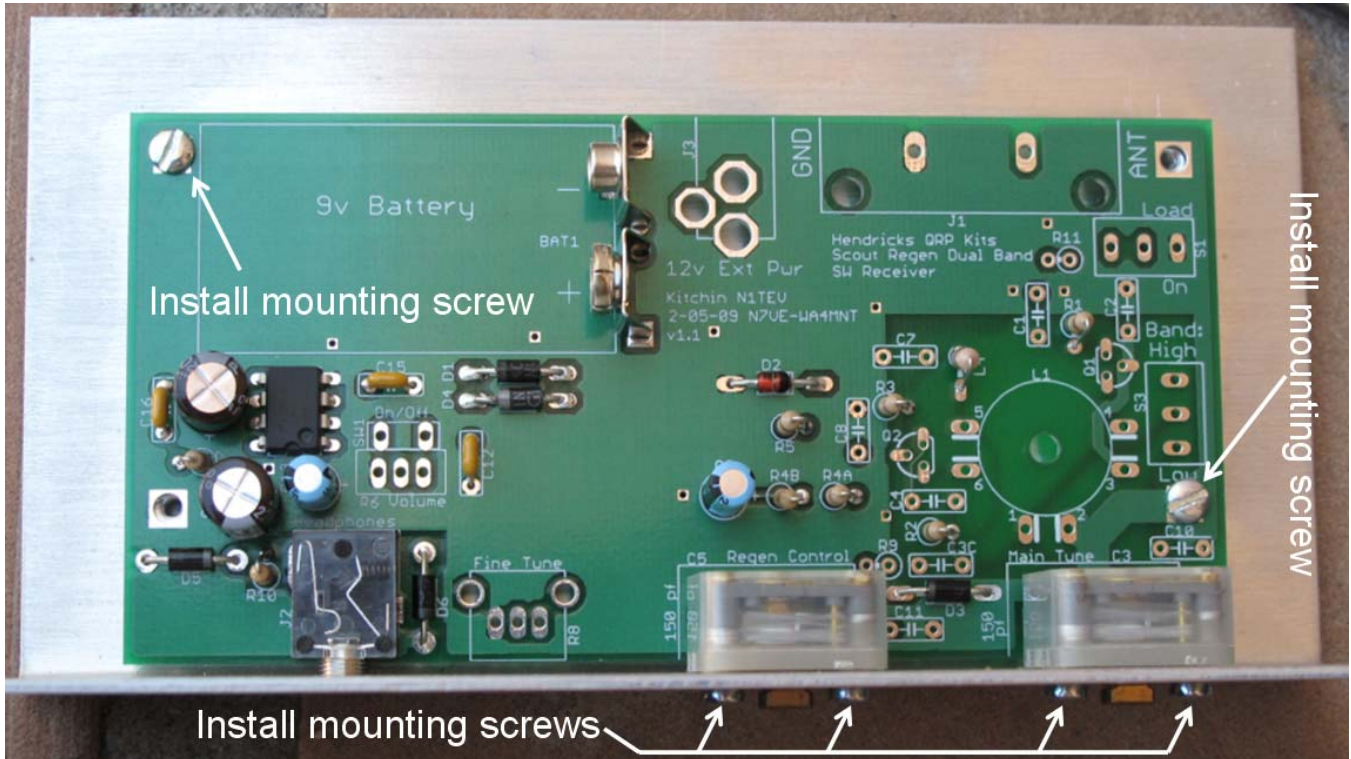

Figure 32. Temporarily mount PC Board to the chassis and C3, C5 to the front panel

In order for C3 and C5 to be soldered with the right spacing above the PC board, the board, C3 and C5 need to be temporarily mounted to the front panel using the mounting screw supplied. Do not over tighten these screws! This is a temporary installation which will be removed after C3 and C5 are soldered in place.

When installing the PC board, shift the board on the mounting screws to center the headphone jack in the center of its front panel hole, then tighten the two PC board mounting screws shown above.

When mounting C3 and C5 to the front panel, the main tuning shafts should be shifted to place the shaft in the center of it front panel hole.

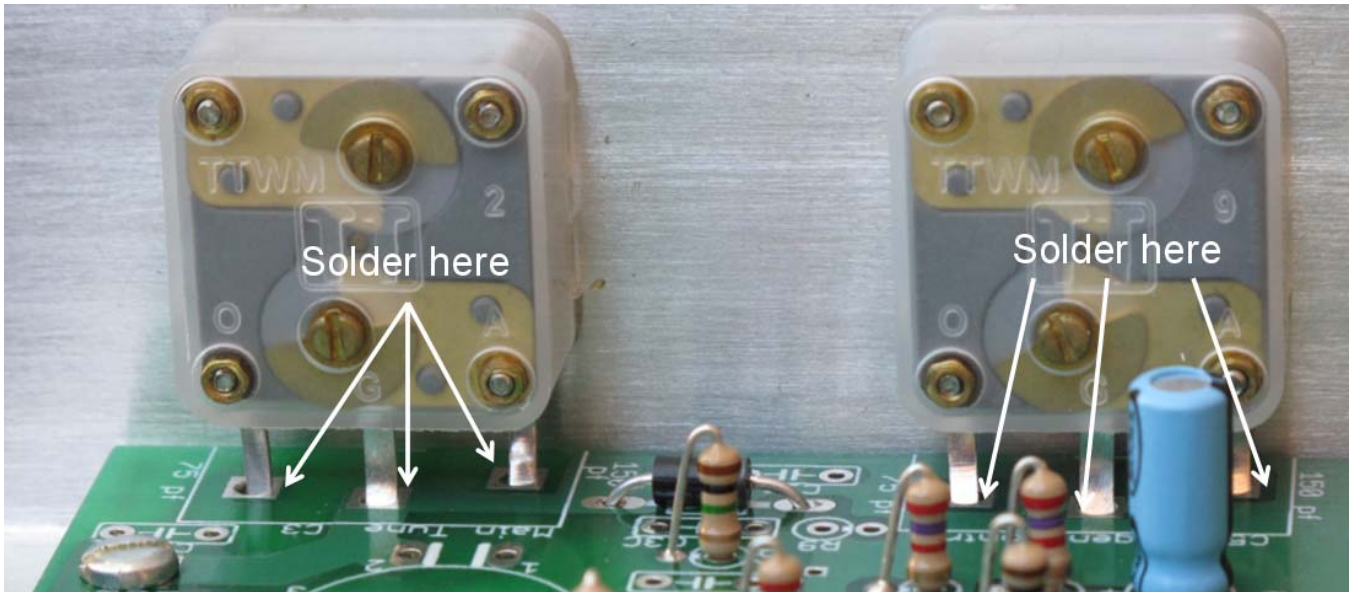

Figure 33. Solder points shown for C3 and C5

□ Solder C3 and C5 to the *top side* of the board as shown above. ***When soldering these leads, avoid melting the plastic cases of C3 and C5.*** If you cannot get to all the leads without melting the case, try to get at least ***two of the three leads*** on both C3 and C5.

The above figure shows parts in the way, but at this point those parts have not yet been installed, so the leads for C3 and C5 should be easy to get to.

When the leads for C3 and C5 have been soldered from the top side, remove the mounting for C3, C5 and the PC board and lay those screws aside.

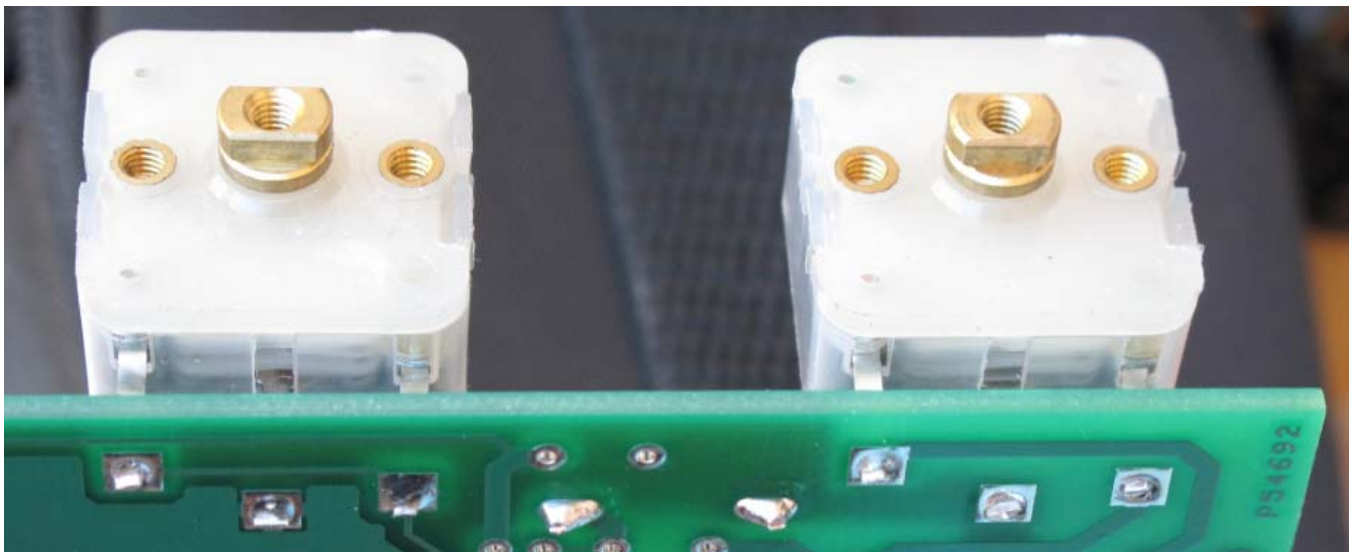

Figure 34. C3 and C5 after soldering and trimming of bottom side leads



After removing the PC board from the chassis, solder C3 and C5 leads from the bottom side and trim off the excess lead length.

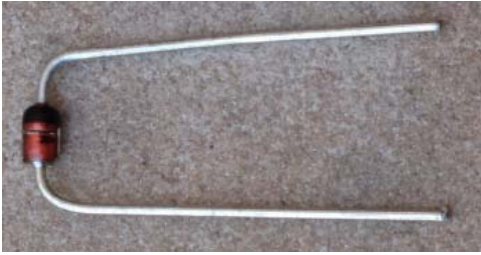

Figure 35. Leading forming shown for the zener diode, D2

Bend the leads for the zener diode (part D2) as shown above so that it will fit in the holes on the board lying flat.

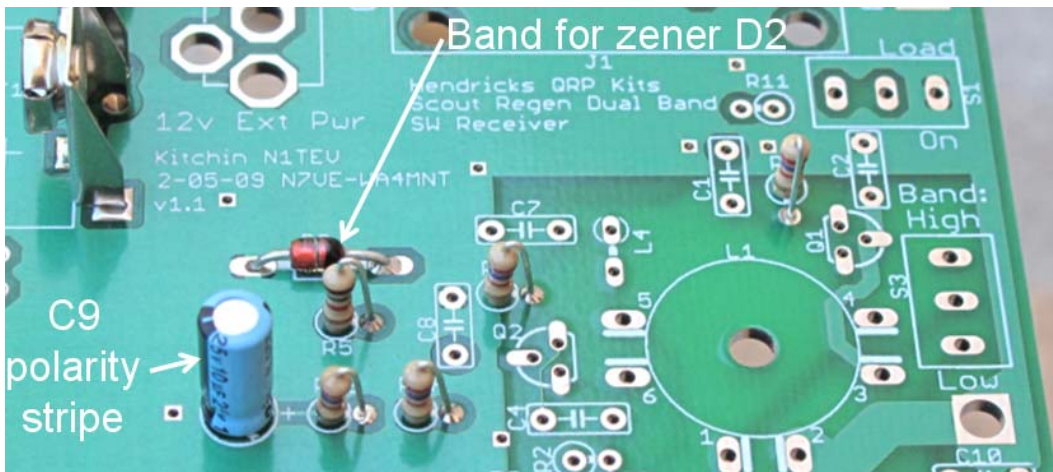

Figure 36. Polarity of D2 and C9

Install □ D2 6.8v zener diode. ***Make sure the diode bands are oriented as shown above.*** The diode body should be mounted flush with the surface of the board.

□ Install C9, a 10 uf capacitor. ***Make sure the “-“ polarity band is oriented as shown above.***

Install four 2.7K resistors (red/violet/red/gold) □ R1, □ R3, □ R4A, and □ R4B. The resistor bodies should be mounted flush with the surface of the board as shown above.

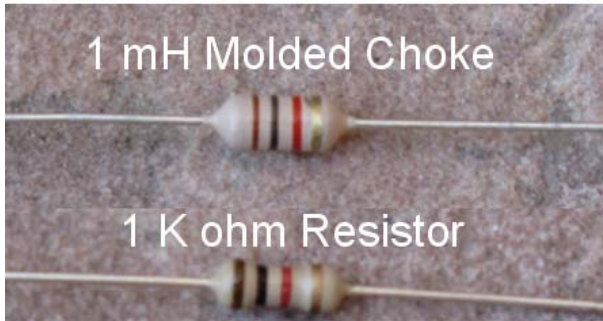

Figure 37. Comparison between a 1K resistor and a 1 mH molded choke

**Caution:** The next step installs a 1K resistor (Brown/Black/Red/Gold). *The 1K resistor and the 1 mH choke both have the same markings!* The desired 1 K resistor is the same size as the other resistors while the molded choke is fatter than the resistors. *Find both parts (shown below – 1K resistor and 1 mH choke), figure out which one looks more like the other resistors and use that 1K resistor in the next step.* The figure above shows the visual differences between the two parts. The figure below shows both the 1K resistor and 1 mH choke installed as an additional visual reference between the two parts.

Install R5, a 1 K resistor (Brown/Black/Red/Gold).

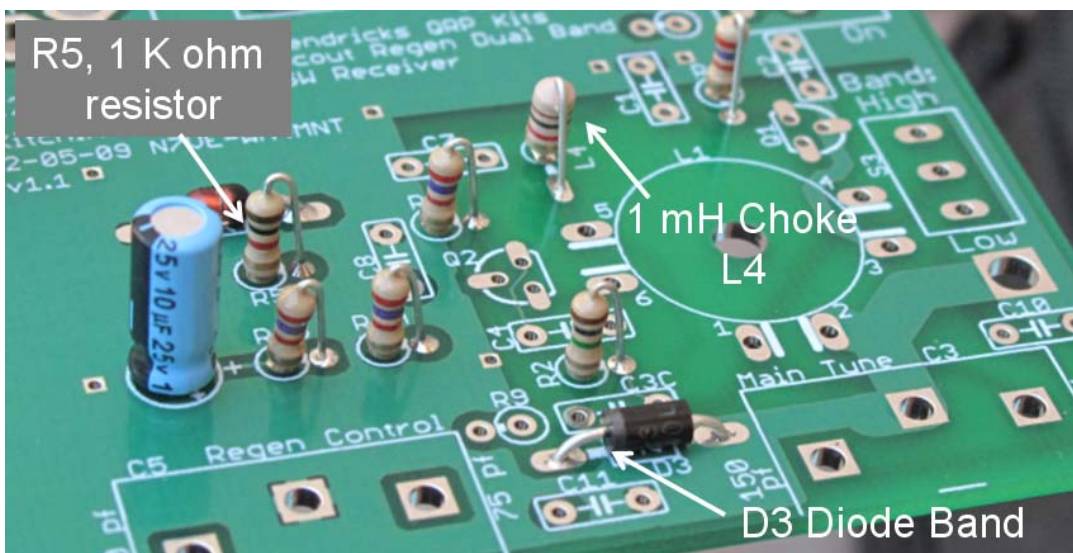

Figure 38. D3 orientation shown. 1 mH choke and 1 K resistor shown installed

Install L4, a 1 mH choke (Brown/Black/Red/Gold). Mount it vertically the same as a resistor.

Install D3, a 1N4004 diode. **Important! Install the diode with the banded end pointed as shown above.** The band on the diode should match the board outline.

Install  R2 and  R9 both 1 M ohm resistors (Brown/Black/Green/Gold).

Install  R11 a 51 ohm resistor (Green/Brown/Black/Gold).

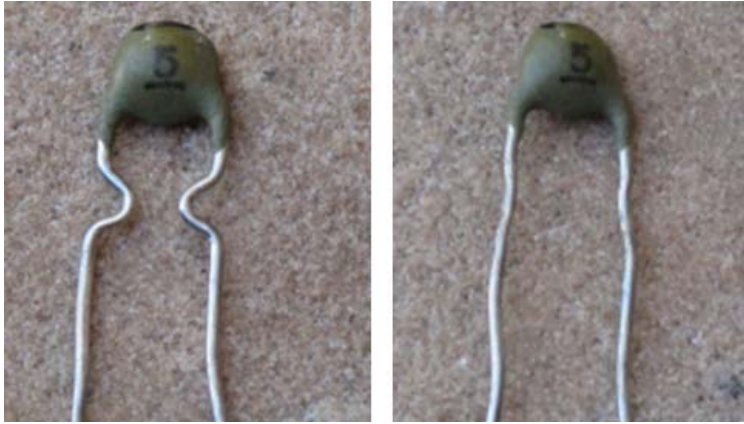

**Figure 39. C3C before and after. Leads need to be straightened out**

Straighten out the leads of the 5 pf capacitor as shown in the figure above.

Install C3C, a 5 pf capacitor.

Install C4, a 100 pf capacitor marked as “101”

Install C10, a 39 pf capacitor marked as “39”

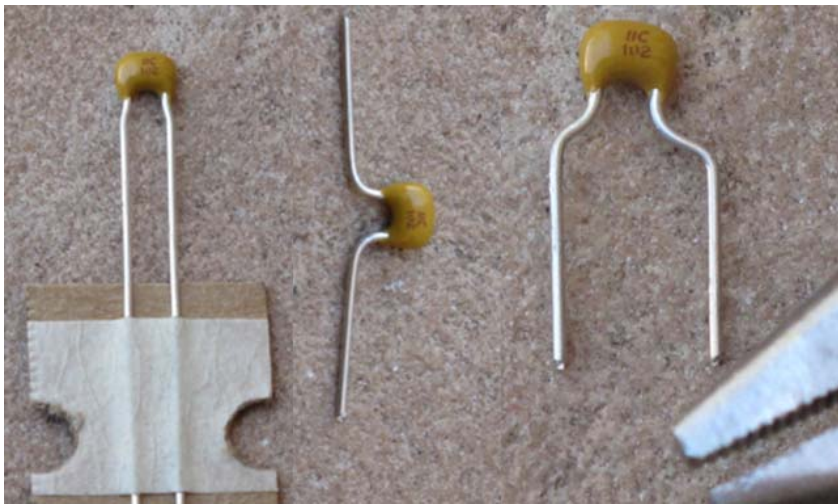

**Figure 40. Forming leads for C8. Leads spacing is too narrow.**

C8, a 1000 pf capacitor has leads that are too narrow for its mounting holes. The diagram above shows how the lead spacing for the capacitor is doubled. First the leads are straightened out to the side by hand, then a pair of needle nose pliers are used to bend the leads down at a 2x wide spacing.

Install C8, a 1000 pf capacitor marked as “102”

Install  C1,  C2,  C7, and  C11 0.01 uf capacitors (marked “103”).

## Regen Detector Section, Part 1 tests

- Connect the 9v battery to the battery clips

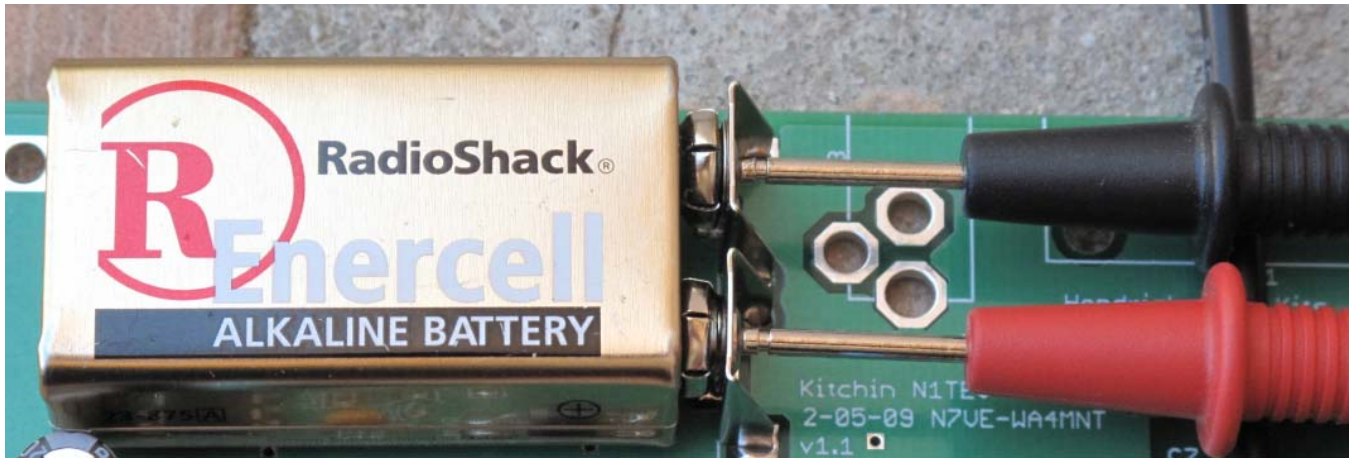

Figure 41. Measuring the voltage across the installed 9v battery.

- Measure the voltage across the battery clips using a voltmeter set to the “DC volts” setting. The voltage should read somewhere in the 8 to 9v range depending on the freshness of the battery

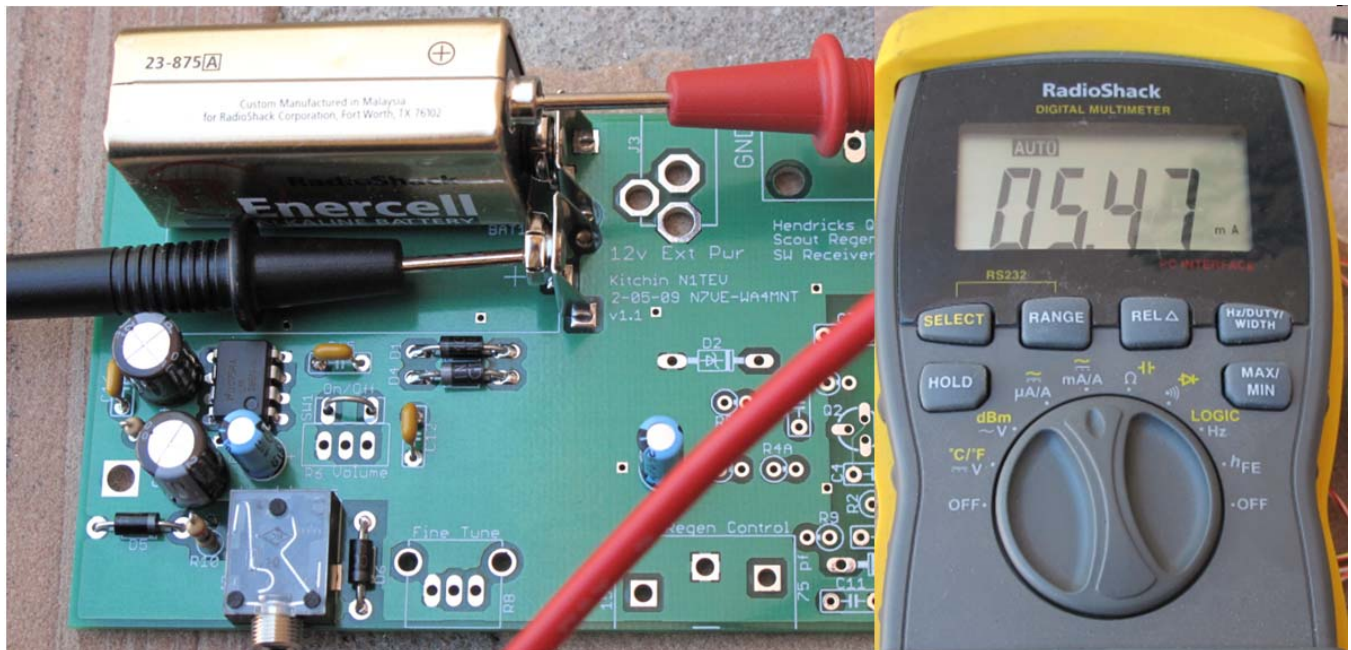

Figure 42. Measuring the current drain of the audio amplifier section

□ Measure the current drain of the kit to this point. The above figure refers to the meter configuration that was used in the first section. Make sure the voltmeter is placed in the “DC current” mode.

In this prototype, the current was 5.47 ma. This measured current drain is about 1 ma higher than the current that was seen in the first section (4.56 ma). The actual current difference measured will vary from board to board due to variations in battery voltages (use a fresh 9v battery), but should be around 1 ma. 2 or 3 ma or more than the measurement in the first section (4.56 ma) would tend to show a problem, while much less current increase change (such as 0.5 ma or less) probably also indicates a problem.

*After these tests are finished, remove the 9v battery.*

*Make sure to switch the volt meter out of the “current” mode into the “voltage” mode!*

## Regen Detector Section, Part 2

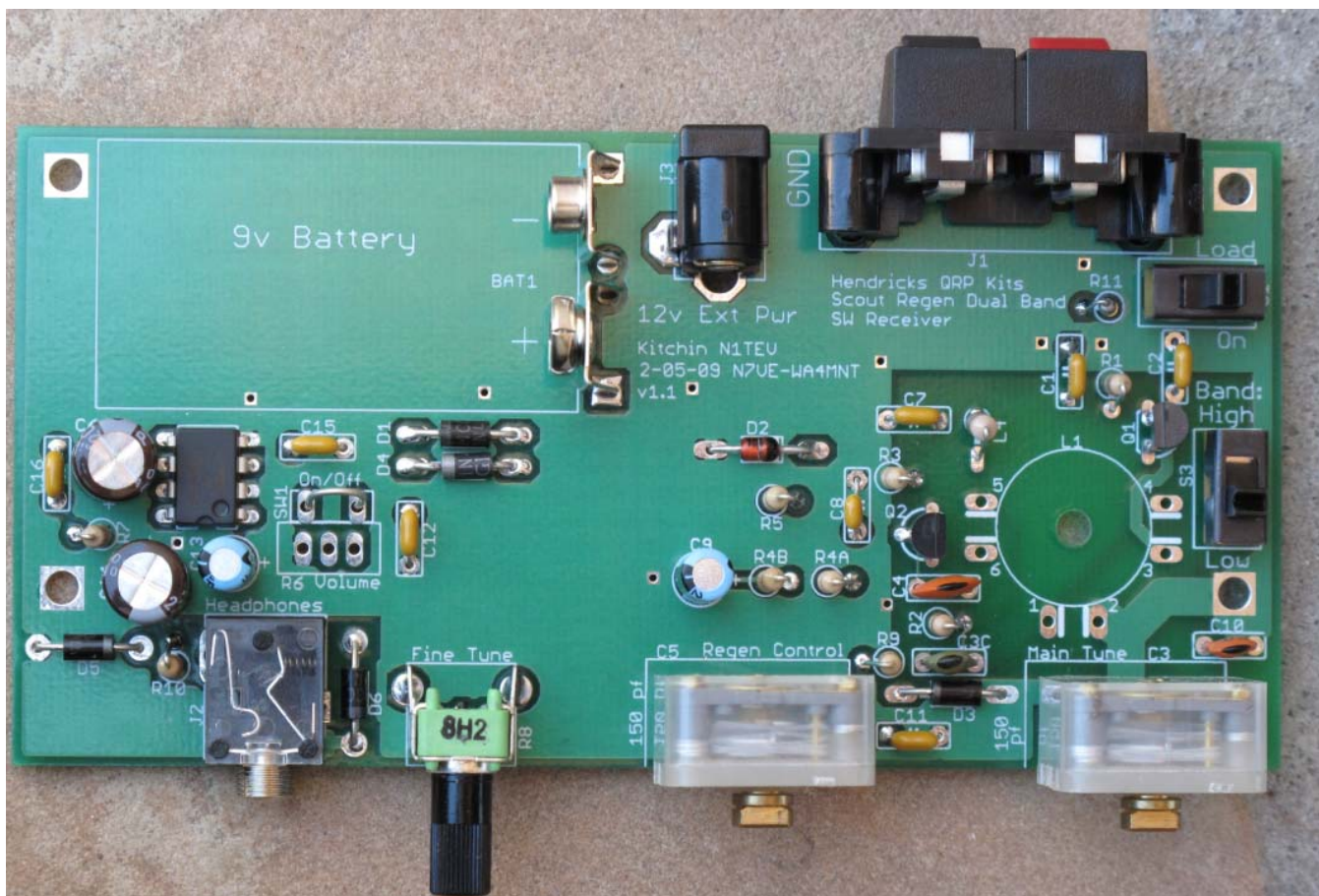
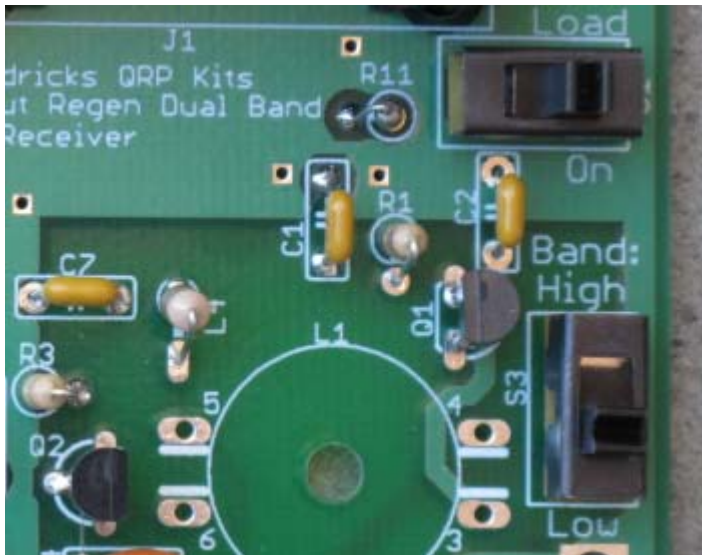

Figure 43. In this section we will install most of the larger hardware pieces on the right side.

- Install J1, the antenna connector as shown in the figure above. The jack snaps into the mounting holes, so make sure the jack is mounted flush with the board before soldering it in place.
- Install J3, the 12v power jack as shown in the figure above. The holes for this jack are large, so make sure the pins get soldered to the pads.

The variable resistor R8 needs to line up with the front panel so it is very important that this variable resistor is installed flat against the PC board. Solder one pin first and make sure the device is flat against the board. If it is not, remelt the solder on that pin and adjust the resistor so that it is flat.

- Install R8, the front panel fine tune as shown in the figure above.



**Figure 44. Close up of the two switches S1 and S3.**

The two slide switches tend to lean to one side when they are soldered in place. For both of these slide switches, solder one pin. If the switch is straight, go ahead and solder the other two pins. If it is crooked, remelt the one soldered pin with the soldering iron and straighten it out. Again, once the switch is straight, solder the other two pins.

Install  S1, and  S3 which are both slide switches.

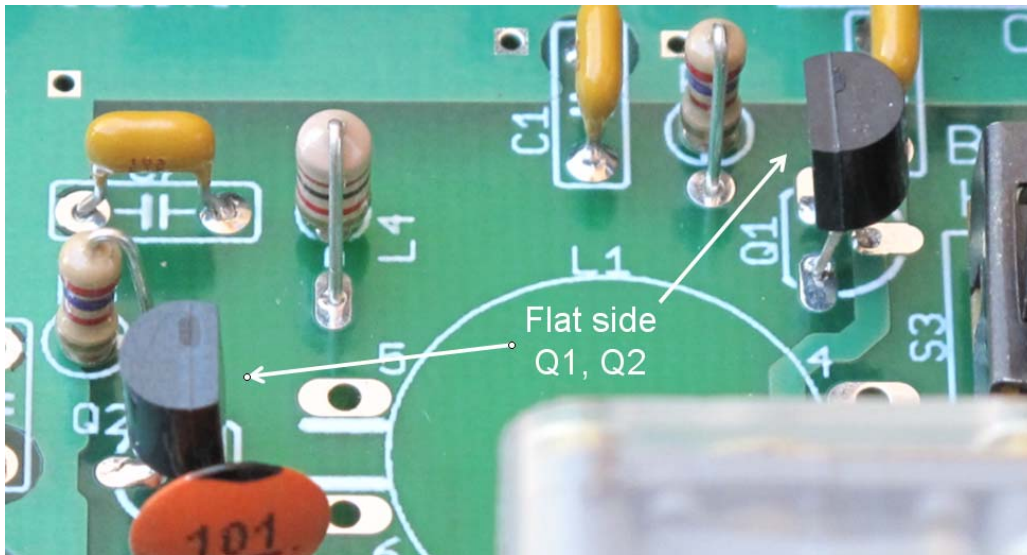

Figure 45. Q1 and Q2 mount with flat side matching the silk screen for the part

- Install Q1, a 2N3904 transistor as shown in the diagram above. *Make sure the flat side of the transistor matches the silk screen of the board.*
- Install Q2, a 2N5485 transistor as shown in the diagram above. *Make sure the flat side of the transistor matches the silk screen of the board.*

## Regen Detector Section, Part 2 tests

- Connect the 9v battery to the battery clips

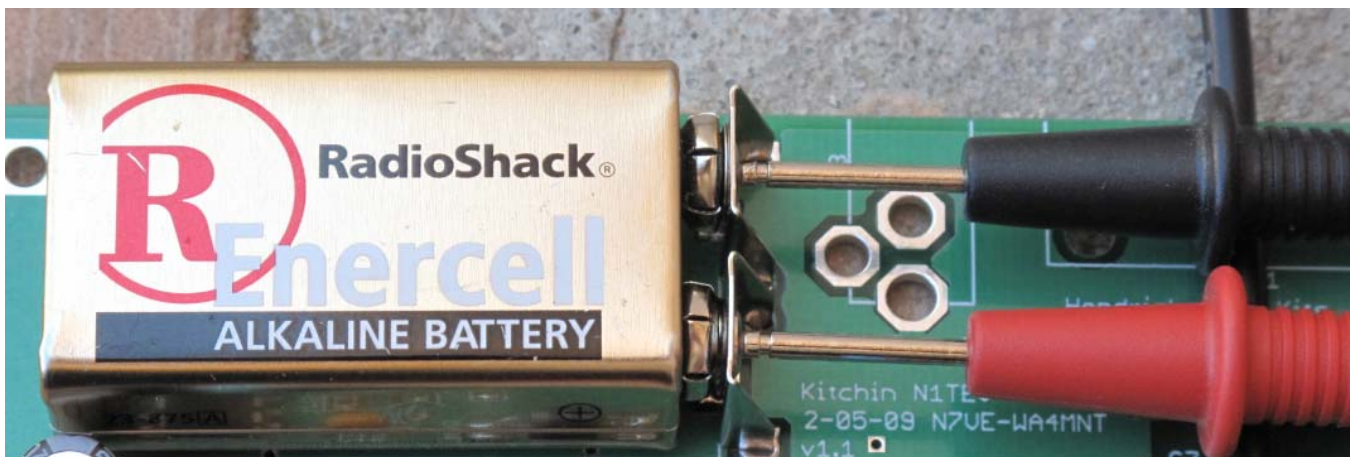

Figure 46. Measuring the voltage across the installed 9v battery.

- Measure the voltage across the battery clips using a voltmeter set to the “DC volts” setting. The voltage should read somewhere in the 8 to 9v range depending on the freshness of the battery

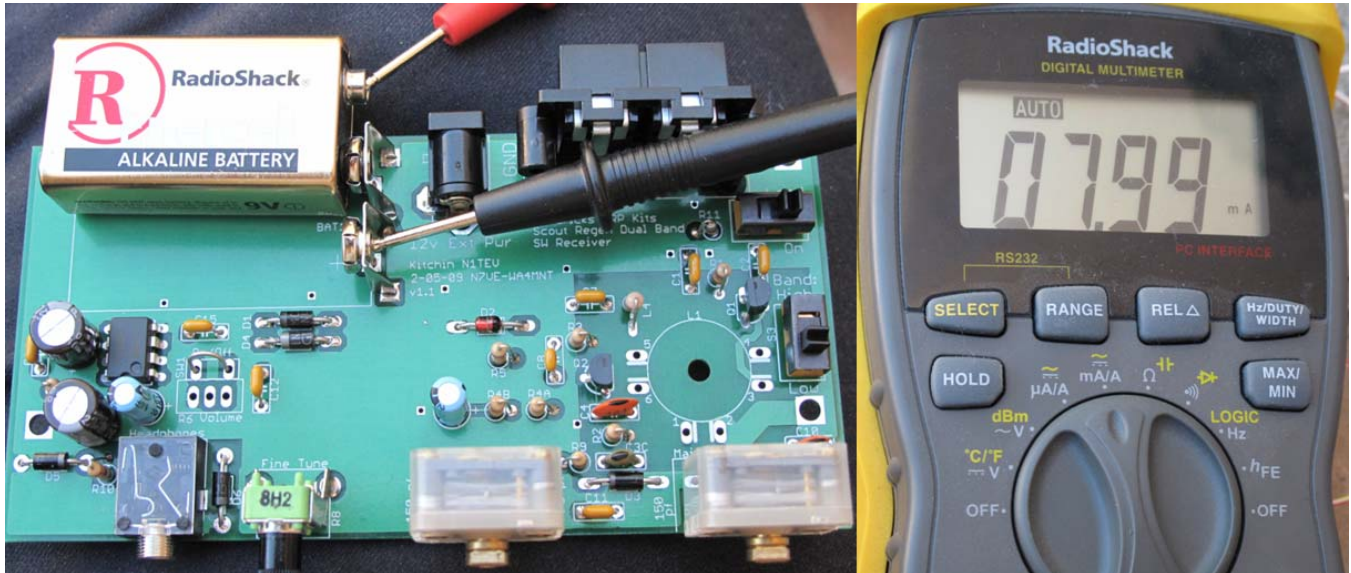

Figure 47. Measuring the current drain of the kit to date section

- Measure the current drain of the kit to this point. The above figure refers to the meter configuration that was used in the first section. Make sure the voltmeter is placed in the “DC current” mode.

In this prototype, the current was 7.99 ma. This measured current drain is about 2.5 ma higher than the current that was seen in the first section (5.47 ma). The actual current difference measured will vary from board to board due to variations in battery voltages (use a fresh 9v battery), but should be around 2.5 ma. 4 ma or more than the measurement in the first section (5.47 ma) would tend to show a problem, while much less current increase change (such as 1.5 ma or less) also probably indicates a problem.

*After these tests are finished, remove the 9v battery.*

*Make sure to switch the volt meter out of the “current” mode into the “voltage” mode!*

## Adding Decals to the Case

The kit is almost done at this point. Since the PC board will shortly be placed in the chassis, now is a good time to stop and add the decals to the chassis.





The decals are applied the same as model decals. Cut around each group of text or symbols you wish to apply, leave a border. It doesn't have to be perfect as the background film is transparent. Apply the decals to a bare chassis. Do them before you mount the circuit board, or you will have to remove the board.

**Thoroughly clean the surface of the panel to remove any oils or contamination.**

Use the diagram below to place your decals. Make ***SHORTWAVE REGENERATIVE RECEIVER*** and ***www.qrpkits.com*** a single decal, as it will be easier to apply. The large decal for the main tuning has a center mark to place directly over the hole to assist you in placing it.

Trim around the decal, leaving about 1/16" space around the printing. After trimming place the decal in lukewarm water for 10-15 seconds. Handle carefully to avoid tearing. Start to slide the decal off to the side of the backing paper, and place the unsupported edge of the decal close to the final location. Hold the edge of the decal against the panel, with your finger, and slide the paper out from under the decal. Slide the decal around to the right position, as it will float slightly on the film of water. You can use an knife point or something sharp to do this. When in position, hold the edge of the decal with your finger and gently squeeze excess water out from under the decal with a tissue or paper towel. Work from the center, to both sides. Remove any bubbles by wiping gently to the sides. Do this for each decal, and take your time. Allow to set overnight, or speed drying by placing near a fan for a few of hours. When dry, spray two **light** coats of matte finish, Krylon, clear to seal and protect the decals, and allow to dry in between coats. All decals come with two complete sets, in case you mess one up.

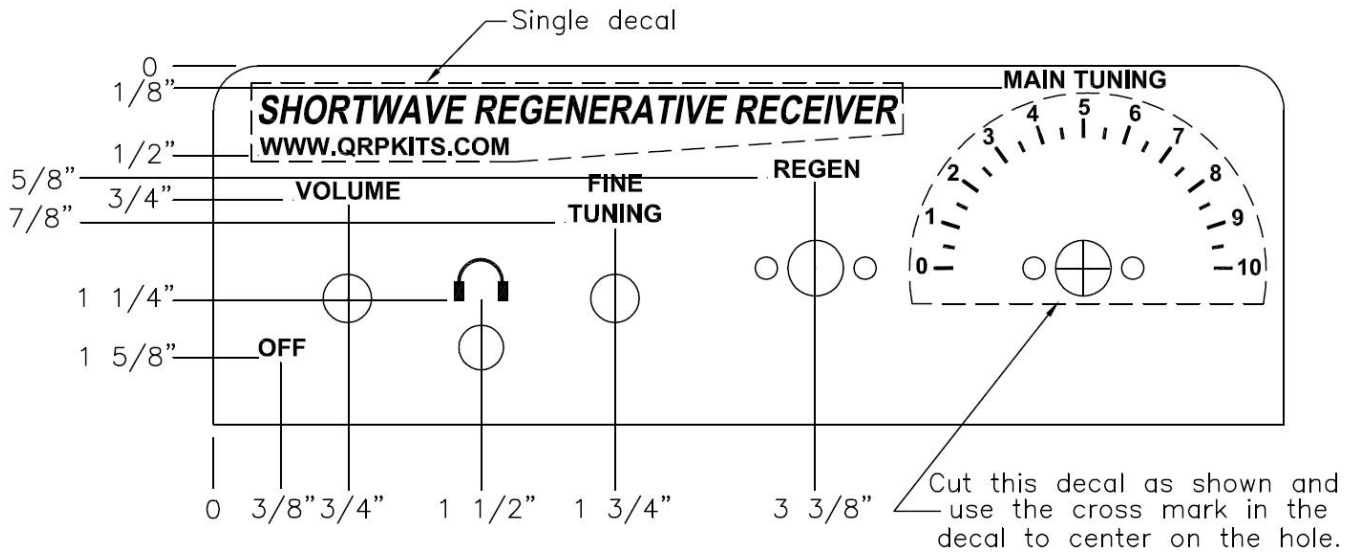

Figure 48. Location of the decals for the front panel.

### Regen Detector Section, Part 3

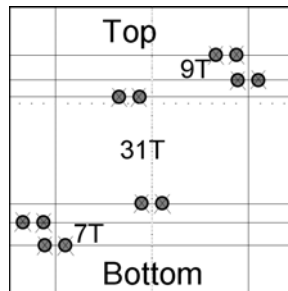

Figure 49. Drilling template for L1, the regen main coil. Template is 1.5"x1.5"



Figure 50. L1 drilling preparation.

The drilling template above is full size (1.5"x1.5"). This needs to be cut out and wrapped around the PVC tube as shown above. Each of the dark grey circles represents a 1/16" hole that needs to be drilled using a 1/16<sup>th</sup>" drill bit so that both ends of all three windings can be secured into place. Finally, the bottom side of the PVC should be colored so that you can remember which end of the tube is the bottom side.

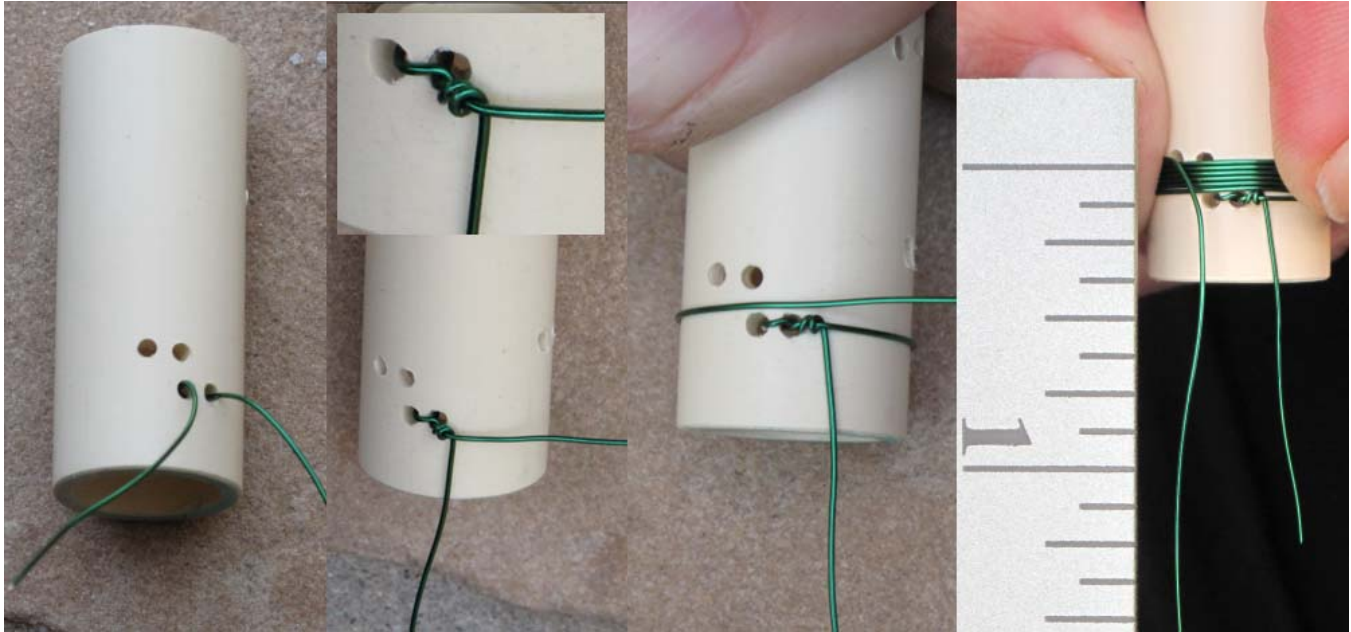

Figure 51. Starting the bottom winding of L1

The winding are all wound using entire spool of supplied wire. At the end of each winding, we will cut off the spool leading some excess lead length.

***It is very important that the wire is wound in the direction shown!*** The winding starts off to the right as shown above.

From the front side, feed the wire into the center of the PVC tube then back out the front as shown is the first picture above. Allow 1" of excess lead length for the bottom end of the coil, then twist the two wires as shown above to anchor that end of the winding as shown in the second picture above. The third picture in the figure above shows how to count ***one turn***. This bottom winding is ***seven turns total*** as shown in the fourth picture. ***Keep the windings taunt at all times!***

Measure 1 1/2" of excess lead length and cut the wire.

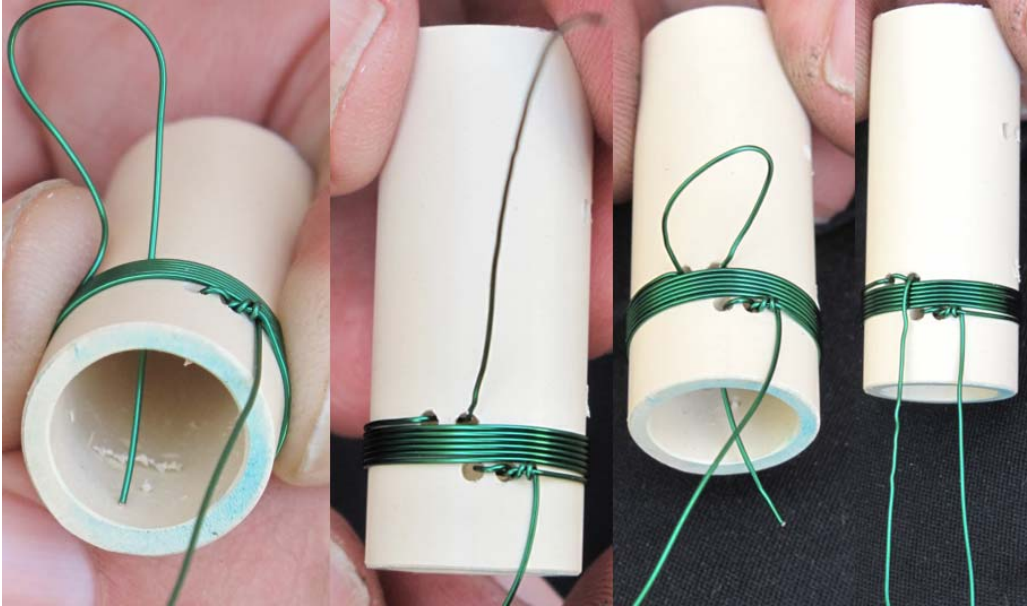

Figure 52. Tying off far end of first winding of L1

The above picture set shows tying off the end of the first winding. ***Keep the windings taunt at all times!*** The first and second pictures above show that the far end is placed into the PVC tube using the first hole, then back out the second hole. Going through these two holes once is not enough to keep the winding secure, so the 3<sup>rd</sup> and 4<sup>th</sup> picture show looping the wire through the two holes one more time.

After this winding is secured, go back and make sure the windings are all bunched “shoulder to shoulder” as shown above.

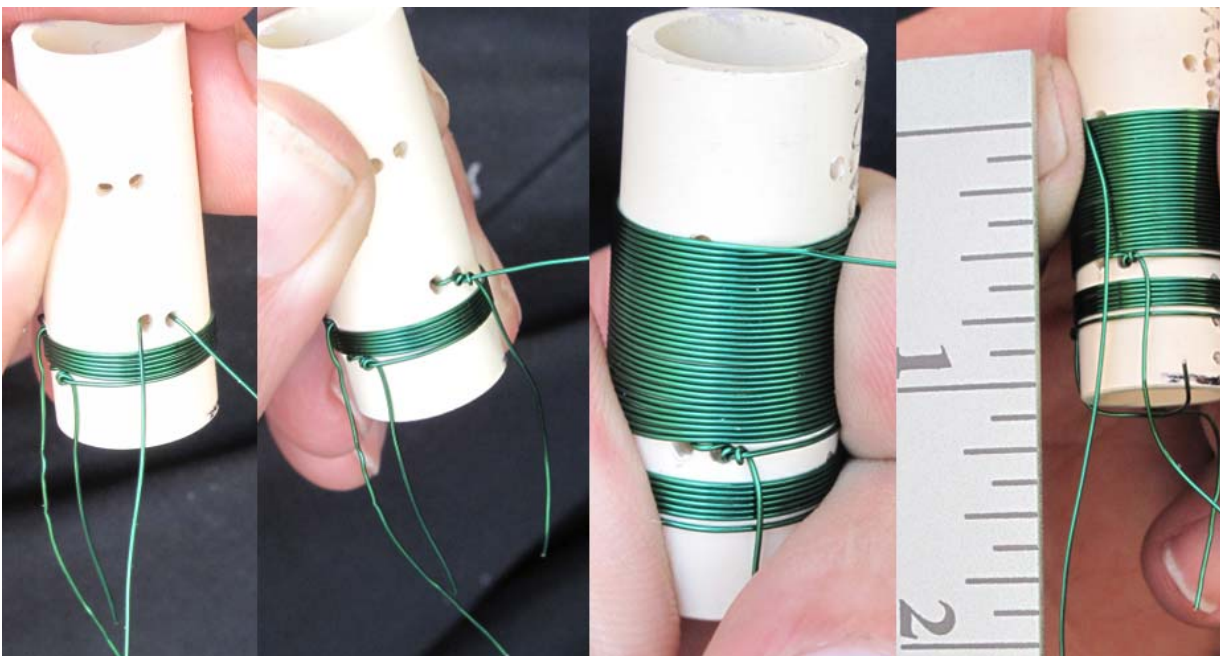
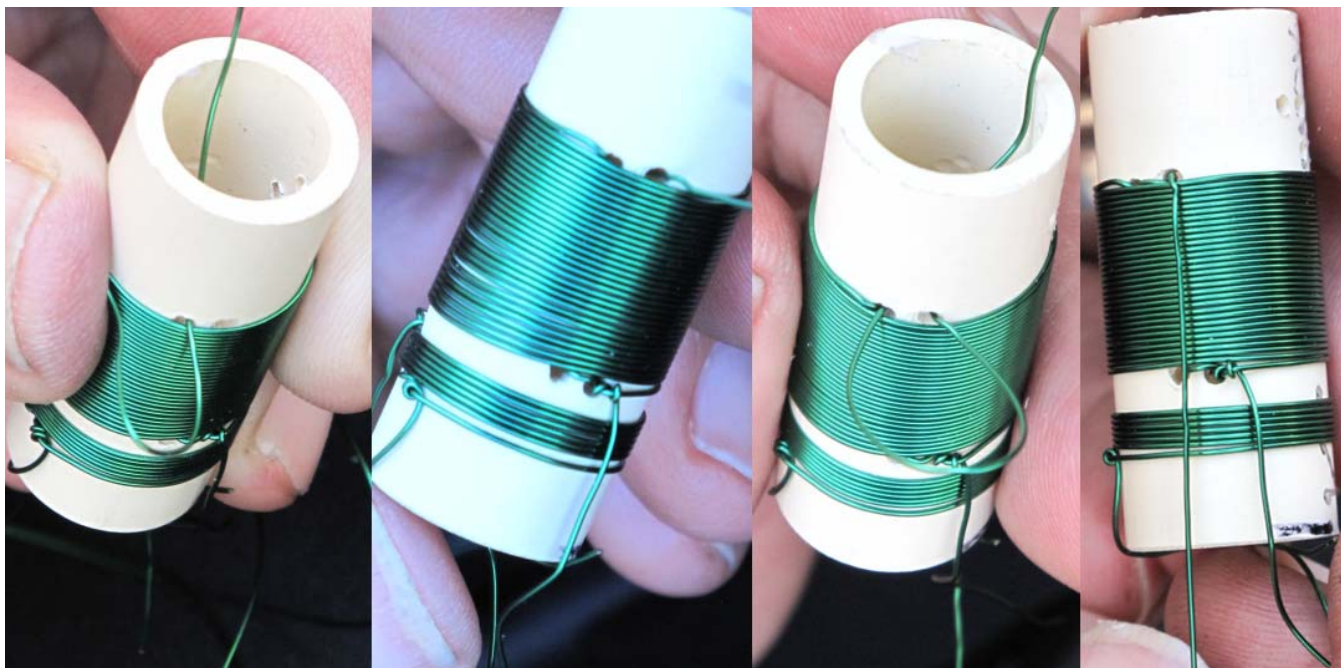

Figure 53. Start of L1 middle winding

***Remember, the winding direction is important! Wind in the direction shown above!***

The second winding is started the same as the first winding as shown in the first and second pictures of the figure above. This winding is 31 turns. These turns must be wound right next to each other in order to fit in the space between the holes. The third picture shows that when the 31 turns are finished, the ending holes might be covered. In this case, the windings will need to be shifted down and bunched together to uncover the ending holes. Measure off 2 inches of excess wire length and cut the wire.



**Figure 54. Tying off L1 middle winding**

The second winding is tied off just like the first winding. Keeping the winding taunt, feed the wire in the first hole and out the second as shown in the first two pictures in the figure above. Since this is not enough to anchor the end securely, feed the wire through both holes one more time as shown in the last two pictures.

After the winding is secure, go around the coil and push the top and the bottom of the middle winding together in order to get rid of any small winding gaps such as can be seen in the second picture above.

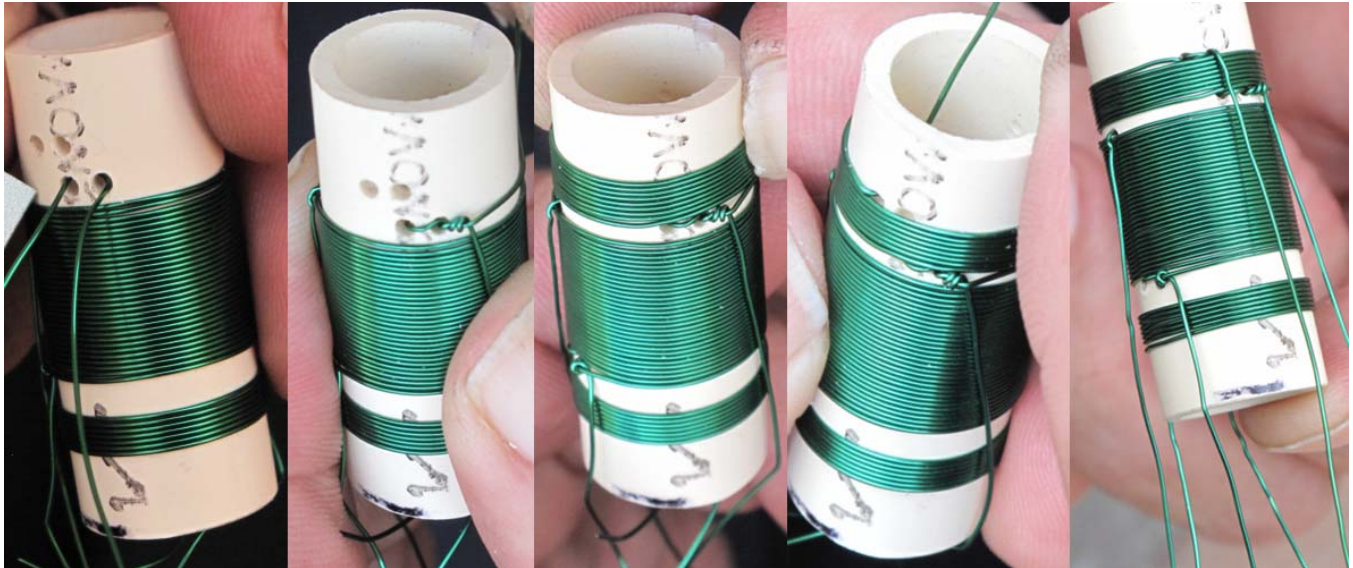

**Figure 55. Top winding of L1**

The top winding is 9 turns. It starts and ends just like the other two windings. Both the start and the end should have 2.5" of excess wire left. The 9 turns will tend to cover the top two holes until the winding is pushed down a bit.



**Figure 56. All six leads of L1 trimmed and solder tinned.**

Finally, all six leads should be pointed towards the bottom end of the coil, and the leads trimmed to  $\frac{1}{4}$ " past the bottom of the coil as shown in the figure above. Each of the six leads need to have the wire stripped and tinned. This is done by adding a bit of solder to the end of the solder tip, then placing the end of the wire in the solder blob. The green insulation used in this kit burns off relatively easily. Starting with the end of the wire, work upwards, constantly feeding in fresh solder until the insulation is burned off to just above the bottom of L1. Once this is done, clean the solder tip, add fresh solder one more time and "clean up" the exposed wire to leave a shiny "tinned" wire behind. Do this for all six leads.

Many, many problems have been traced to the insulation on these wires not being properly removed before the coil is soldered to the board. Double check this by taking a multi-meter, and check to see if the stripped portion on one end of a winding measures 0 ohms to the other stripped end of the same winding. There are three windings, so three of these preliminary checks are needed.

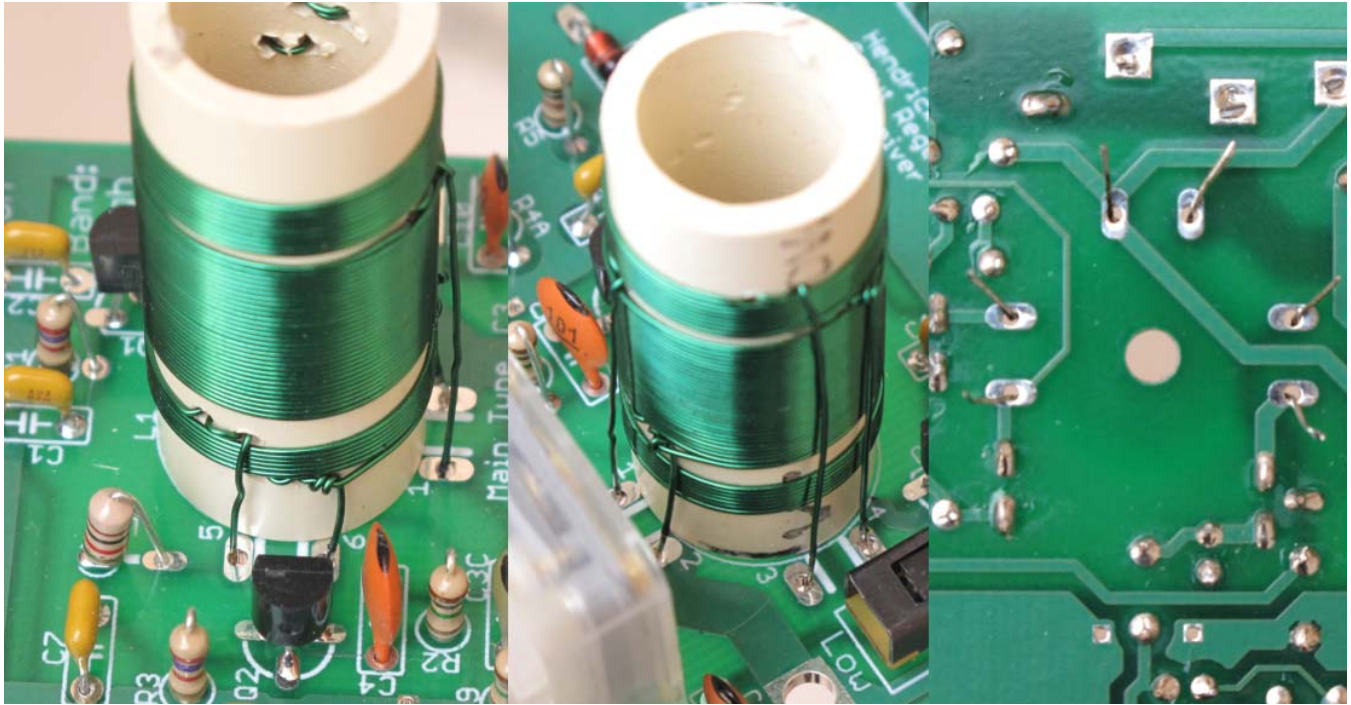

Figure 57. L1 Mounted in the PB board

***Do not solder!*** Place the wires from L1 into the holes on the PC board as shown above. We want to make sure the wires are in the right holes before the leads get soldered in place and cut short!

- Make sure the bottom winding leads are in the holes marked 5 and 6. It is very important that the bottom lead of this bottom winding goes into the hole marked “6” as shown above and that the top wire of this winding goes into the hole marked “5” as shown above. ***Do not solder!***
- Make sure the middle winding leads are in the holes marked 1 and 2. It is very important that the bottom lead of this bottom winding goes into the hole marked “2” as shown above and that the top wire of this winding goes into the hole marked “1” as shown above. ***Do not solder!***
- Make sure the top winding leads are in the holes marked 3 and 4. It is very important that the bottom lead of this bottom winding goes into the hole marked “4” as shown above and that the top wire of this winding goes into the hole marked “3” as shown above. ***Do not solder!***

Tug slightly on each of the six wires on the bottom side of the board in order to both straighten them out and take out the slack in the wire. Don’t pull to hard as we do not want to break a wire at this point!

- Solder L1 in place keeping L1 snug against the top of the PC board.

At this point, we want to run a few quick go/no go tests on L1 and its windings as they have now been soldered to the board.

Place multi-meter across L1 pins 5 and 6 and check for zero ohms. This should be less than 1 ohm. If the measurement shows open or a large resistance, the leads may not have been stripped and soldered properly.

Place multi-meter across L1 pins 1 and 2 and check for zero ohms. This should be less than 1 ohm. If the measurement shows open or a large resistance, the leads may not have been stripped and soldered properly.

Place multi-meter across L1 pins 3 and 4 and check for zero ohms. This should be less than 1 ohm. If the measurement shows open or a large resistance, the leads may not have been stripped and soldered properly.

Remove the power switch short installed earlier.

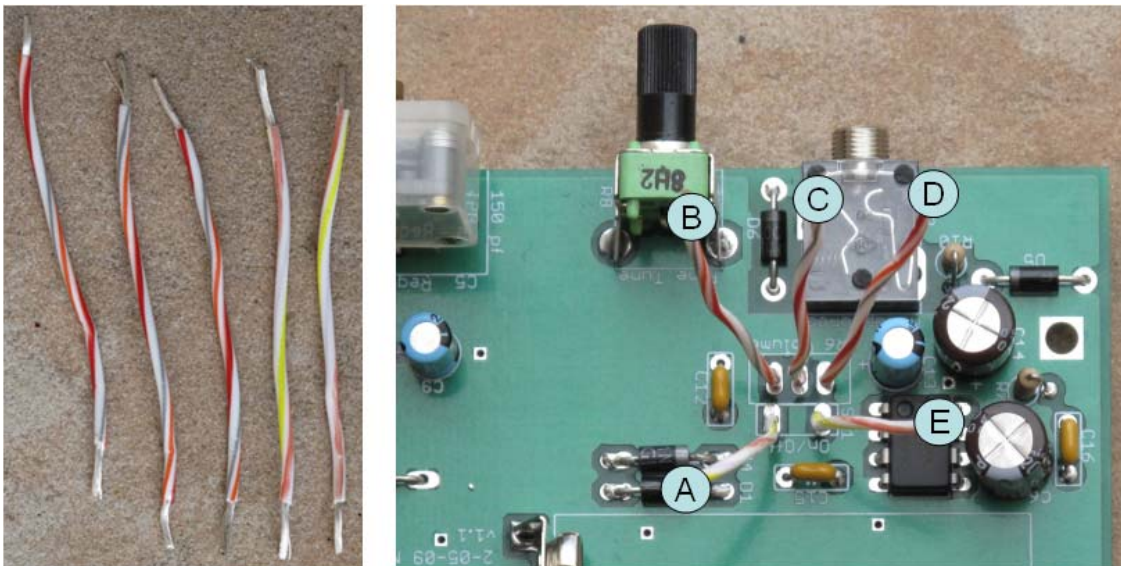

**Figure 58. Cut five wires 2.5" in length and install on R6 pads**

Cut five wires 2.5" in length and strip of 1/8" of insulation off of each end. This can be done by pressing against the wire, rotate the wire a bit, press the knife again and repeat all the way around the wire. Then the insulation can be pulled off with a little bit of effort. Strip both ends of all five wires. Mount all five wires in the holes for R6 as shown above.





**Figure 59. R6 (back view/front view) mounted to the front panel.**

□ Mount R6 to the front panel. The washer for R6 is placed on the front side of the panel between the nut and the panel.

Next, mount the PCB to the chassis so that R6 can be connected to the wires on the PC board.



**Figure 60. Mount the PC board with the four corner screws. Keep screws loose!**



**Figure 61. Mount C3 C5 to front panel. Keep screws loose!**

Slide the PC board to center the headphone jack in its front panel hole, then tighten the four PCB screws. Next tighten the four mounting screws for C3 and C5.

□ Connect R6 lugs to the wires on the board. First connect the two outside wires, Wire A to R6 terminal A, Wire E to R6 terminal E as shown in Figure 58 and Figure 59. Next connect the center of the three wires, Wire C to R6 terminal C. Finally connect Wire B to R6 terminal B and Wire D to R6 terminal D.



Figure 62. Mounting hardware for the shafts for C3 and C5.

□ Add the shaft hardware to C3 and C5.

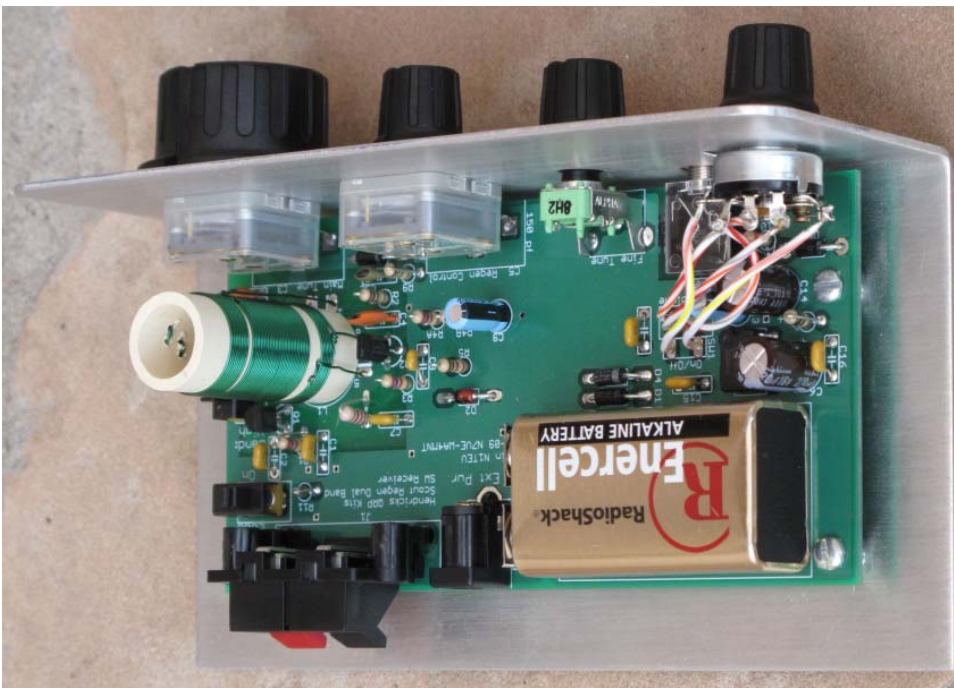

Figure 63. Knob order on the front panel.

□ Add the knobs to the front panel shafts

□ Add feet to the bottom of the chassis

## Regen Detector Section Part 3 tests

- Connect the 9v battery to the battery clips

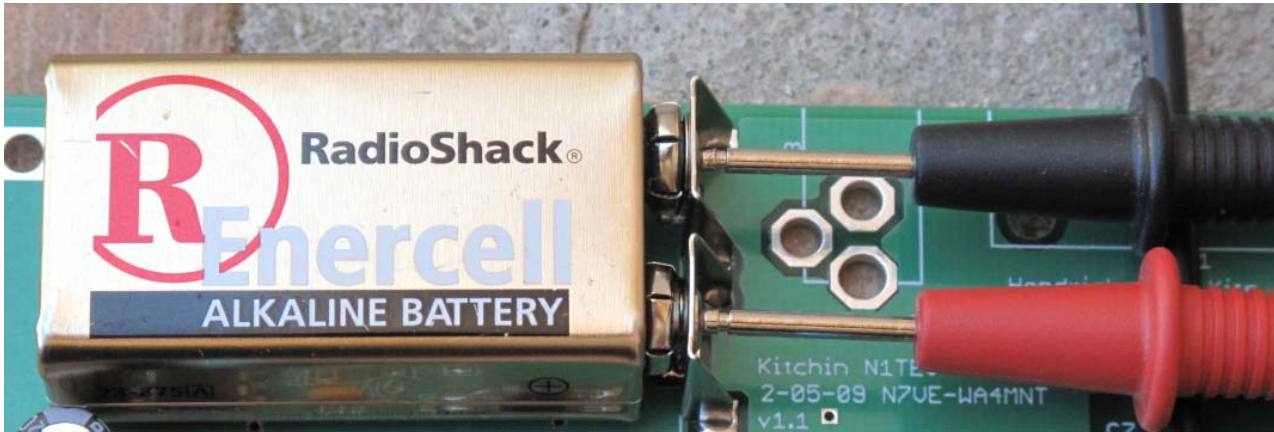

Figure 64. Measuring the voltage across the installed 9v battery.

Now that the volume control and power switch have been added, turn the receiver on via the volume control. Measure the voltage across the battery clips using a voltmeter set to the “DC volts” setting. The voltage should read somewhere in the 8 to 9v range depending on the freshness of the battery



Figure 65. Measuring the current drain of the kit to date section

- Measure the current drain of the kit to this point. The above figure refers to the meter configuration that was used in the first section. Make sure the voltmeter is placed in the “DC current” mode.

In this prototype, the current was 8.37 ma. This measured current drain is about 0.4 ma higher than the current that was seen in the last section (7.99 ma). The actual current difference measured will vary from board to board due to variations in battery voltages (use a fresh 9v battery), but should be around 0.4 ma. 1 ma or more than the measurement in the first section (5.47 ma) would tend to show a problem, while much less current increase change (such as 0.2 ma or less) may indicate a problem.

After this test, remove the voltmeter, and connect the battery as normal.

□ Plug in a pair of headphone into the headphone jack and connect 3 to 10 feet of wire to the red terminal of J1 the antenna jack. Make sure the volume control is turned on with the volume turned all the way up. Vary the regen control and listen for a increase in hiss (and perhaps a small “thump”) as the knob is turned through its range. With the regen control turned counter clockwise until a hiss is heard, tune the tuning knob and listen for “whistles”. These signal can be tuned more easily using the “fine tune” control. If you can hear the regen control hiss (no hiss to hiss), and you can fine whistle signals using the main tuning knob, and if the fine tune knob allows finer tuning control of these signal, all is working.

## Microphonic Effects

**Note:** If gently taping the front panel of the receiver creates a sustained noise (microphonics), this is the result of L1 vibrating. If L1 is in contact with the PCB, that contact alone should dampen this effect to the point where it is not a problem. If you are having a problem, this can be easily fixed by placing a small pea sized amount of hot glue on the back side of L1 near C1 that connects the PCV body of L1 to the PCB board, dampening any vibration and getting rid of the microphonic effect.

## Notes on Tuning a Regenerative Receiver

Adapted from How to Become A Radio Amateur c.a. 1960

Turn the regeneration control, all the way clockwise and set the volume control at about ½ way. Advance the regeneration control slowly until the detector goes into a soft hiss as it starts to oscillate. Adjust the volume control to a comfortable level. Reverse rotation of the regeneration control slowly, and the hissing should stop. Go back and forth over this point several times so that you may familiarize yourself with the sound. See how close you can come, in advancing the regeneration control clockwise, to the point where the hissing starts without actually making the hiss start. If you listen carefully, you will hear the background noise come up (in the absence of a signal). This is the most sensitive adjustment point for modulated (phone) signals.

For c.w. (Morse Code) signals, turn the regeneration control counter-clockwise past the point where the hissing starts. Reverse the direction and slowly approach the point where the hissing stops. See how close you can get to this point without making the hissing stop. This is the point for greatest sensitivity for c.w. Strong c.w. signals will block the detector when it is adjusted for this most sensitive condition. In this case, turn the control counter-clockwise as far as necessary to prevent blocking.

Use the Tuning/Frequency control to find a signal. Perform the above procedure on the signal you want to receive.

*< Note: The Scout has both a fine tune and a course tune control. Course tune is used to find signals, fine tune is used to tune them in. >*

At times, advancing the regeneration control too far may result in a high pitched squeal. If this should occur, the control should be retarded. At times, changing the setting of the regeneration control will have some effect on the frequency, so it may be necessary to readjust the Tuning/Frequency control slightly to keep the signal in tune.

You should find plenty of signals at the right time of day or night, using a moderate antenna, that are strong enough to work a small loudspeaker connected to the output jack.

## Other Operating Notes

This is a two band shortwave receiver. The low band covers ~ 3.5 to just over 5 MHz while the high band covers from just over 5 MHz to just over 10 MHz. The time station WWV ought to be heard near the high end of the bottom band (5 MHz) and near the high end of the top band (10.0 MHz).

The receiver MDS is roughly -130 dBm ( 0.1 uV pk) and is thus extremely sensitive. The sensitivity falls off a few dB down at 3.5 MHz. A good general purpose antenna is a 50 to 100 ft wire strung up as high and as in the clear as possible connected to the red antenna terminal input. However, the receiver is sensitive enough to pick up many stations with only a 3 to 10 ft section of wire. Remember, higher and longer is better.

This kit was designed for headphone level listening. The audio output has diode limiters to keep the headphone level from getting too loud for headphone listening. These diode limiters may distort the signal if a very loud signal is being received such as a very strong signal or a sudden static crash. In the case of a very strong signal, simply reduce the volume level until the distortion goes away.

## Parts List by Schematic Reference Numbers

Part	Value	Details
C1	0.01 uf	
C2	0.01 uf	
C3		POLYVARICON
C3C	5 pf	
C4	100 pf	
C5		POLYVARICON
C6	220 uf	
C7	0.01 uf	
C8	1000 pf	
C9	10 uf	
C10	39 pf	
C11	0.01 uf	

C12	0.01 uf	
C13	10 uf	
C14	220 uf	
C15	0.01 uf	
C16	0.01 uf	
D1	1N4004	
D2	1N4736A	
D3	1N4004	
D4	1N4004	
D5	1N4004	
D6	1N4004	
IC1	LM386-N4	
J1	COMPRESSION_JACK	Antenna Jack
J2	HEADPHONE_PCB	Headphone Jack
J3	DC_PWR	12v Power Jack
L1	T50_REGEN	1.5" length 0.5" PVC 5/8" OD
L4	1 mH	Molded Choke (mH, not uH)
Q1	2N3904	
Q2	2N5485	
R1	2.7K	
R2	1M	
R3	2.7K	
R4A	2.7K	
R4B	2.7K	
R5	1K	
R6	10k	Volume control
R7	10	
R8	100K	Fine Tune
R9	1M	
R10	33	
R11	51	
S1	MINI_SPST	MINI_SPST_SLIDE
S3	MINI_SPST	MINI_SPST_SLIDE

## Schematic

